

# Stereolithography

---

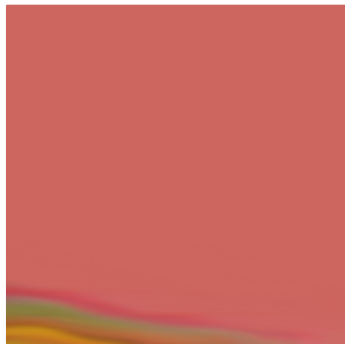
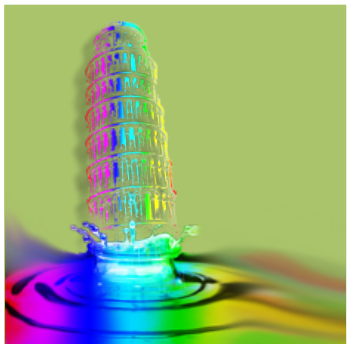
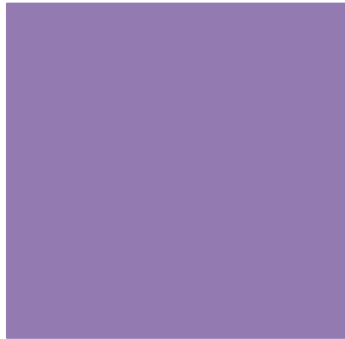

[carmelo.demaria@centropiaggio.unipi.it](mailto:carmelo.demaria@centropiaggio.unipi.it)

# + Before you begin

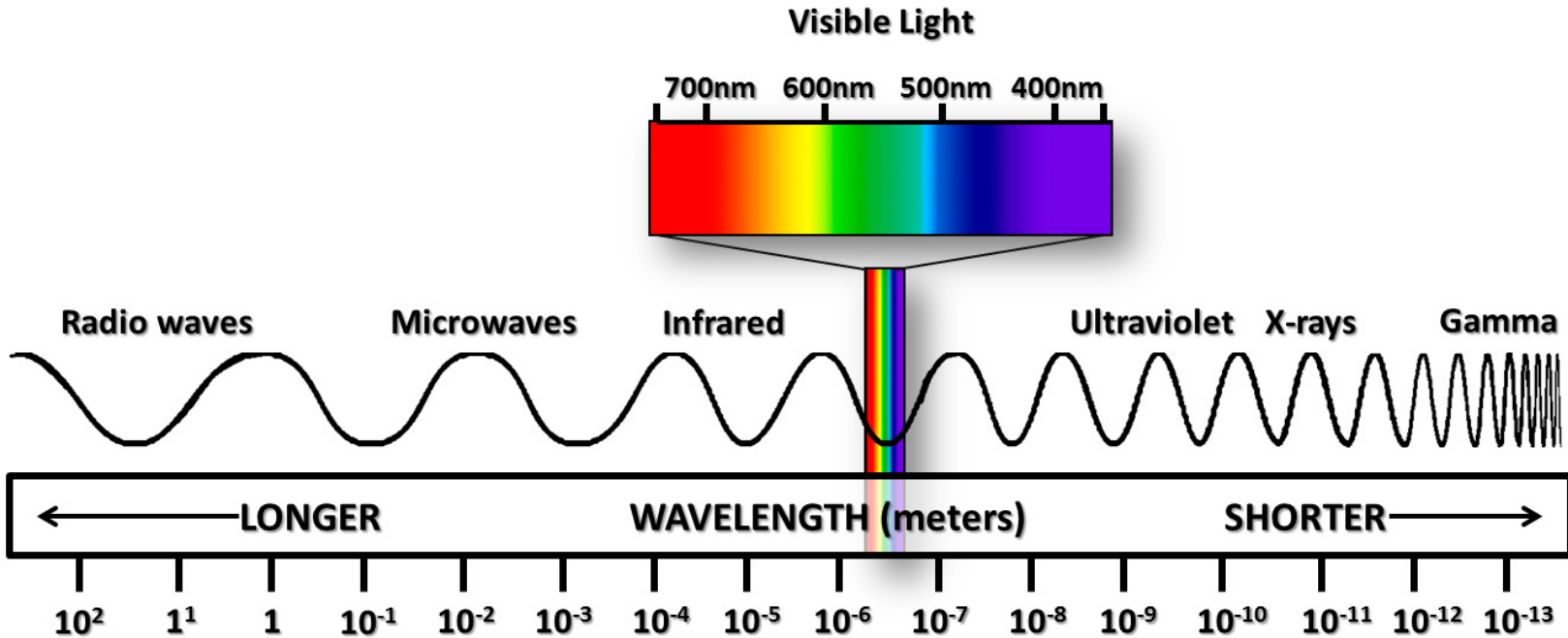

Energy is proportional to frequency

$$v = c/\lambda$$

$$U = h \cdot v$$

# + Stereolithography

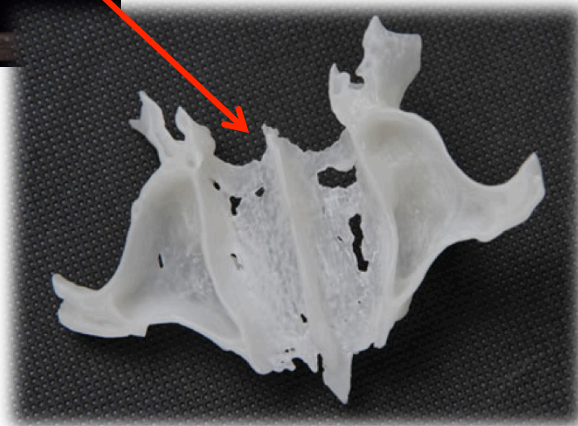
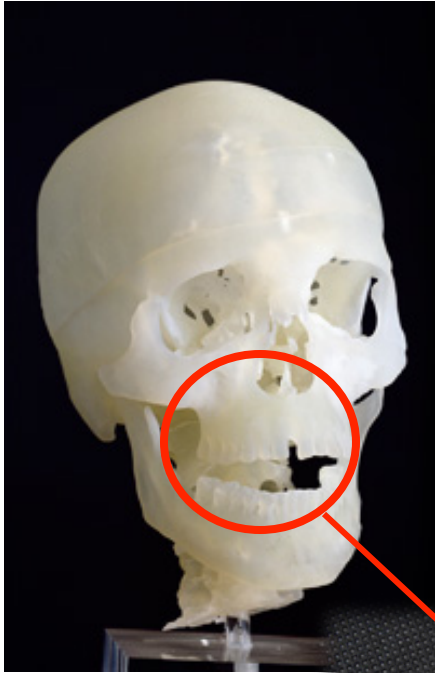

# + Stereolithography

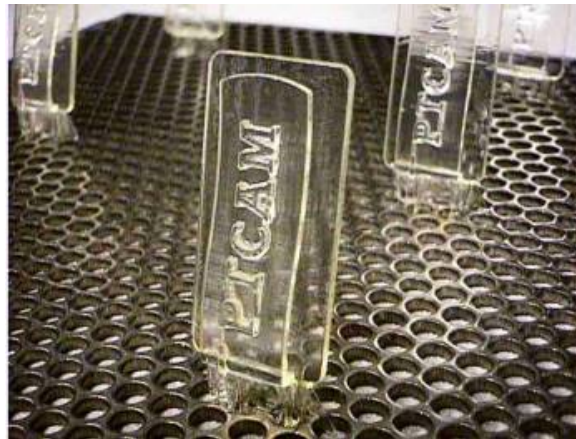
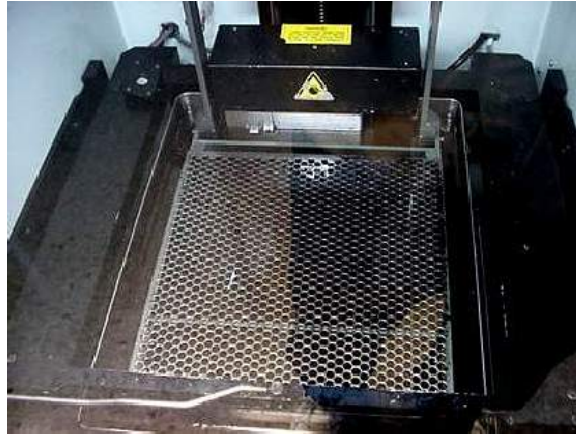

# + What is SLA?

- Stereolithography Apparatus (SLA) is a liquid-based process which builds parts directly from CAD software.
- SLA uses a low-power laser to harden photo-sensitive resin and achieve polymerization.
- The Rapid Prototyping Stereolithography process was developed by 3D Systems of Valencia, California, USA, founded in 1986.
- The SLA rapid prototyping process was the first entry into the rapid prototyping field during the 1980's and continues to be the most widely used technology.



# + The Process (general)

- The process begins with a 3D CAD file.
- The file is digitally sliced into a series of parallel horizontal cross-sections which are then provided to a StereoLithography Apparatus (SLA) one at a time.
- A radiation source draws the cross-section onto a bath of photopolymer resin which solidifies the cross-section.
- The part is lowered a layer thickness into the bath and additional resin is swept onto the surface (typically about 0.1 mm) .
- The radiation source then solidifies the next cross-section.
- This process is repeated until the part is complete.
- Once the model is complete, the platform rises out of the vat and the excess resin is drained.
- The model is then removed from the platform, washed of excess resin, and then placed in a curing light oven for a final curing.



# **PHOTOPOLYMERIZATION**

# + Photopolymers

- Various types of radiation may be used to cure commercial photopolymers, including:
  - gamma rays;
  - X-rays;
  - electron beams;
  - **UV**;
  - Visible light





# + Types of photopolymerization

- In a photocurable resin you have:
  - photoinitiators,
  - reactive diluents,
  - flexibilizers,
  - stabilizers,
  - and liquid monomers.



# + Types of photopolymer

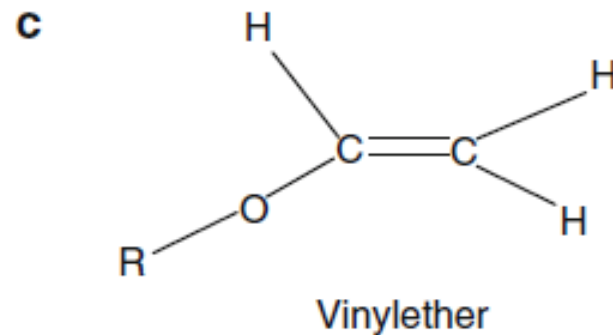
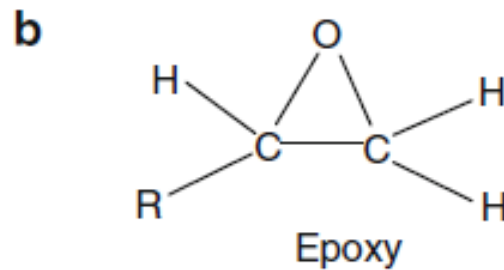
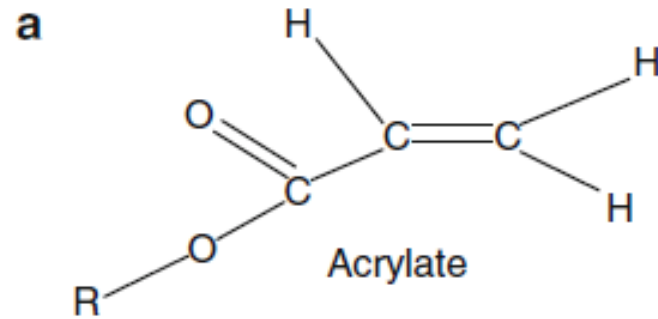

# + Types of photopolymers

- Acrylates
  - High reactivity
  - Inaccuracy (shrinkage and curling)
  - Oxygen inhibition
  - Free-radical polymerization

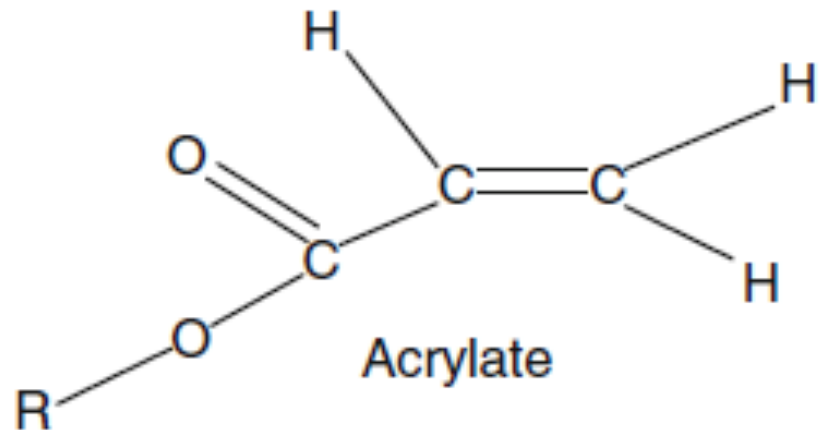

# + Types of photopolymers

- Epoxy
  - Slow “photo-speed”
  - Brittleness
  - Accuracy, harder, stronger (lower dimensional changes)
  - Not Oxygen inhibition (lower photoinitiator concentration)
  - Sensitivity to humidity
  - Cationic polymerization

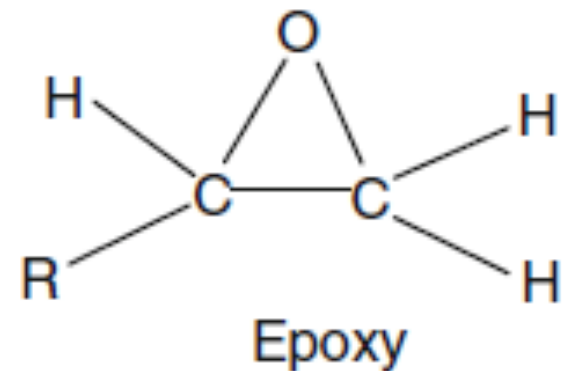

# + Types of photopolymers

- SL resins commercially available today are epoxides with some acrylate content
  - Multifunctional monomers
  - polyester acrylate (PEA), epoxy acrylates (EA), urethane acrylates (UA), amino acrylates and cycloaliphatic epoxies
  - Interpenetrating polymer network

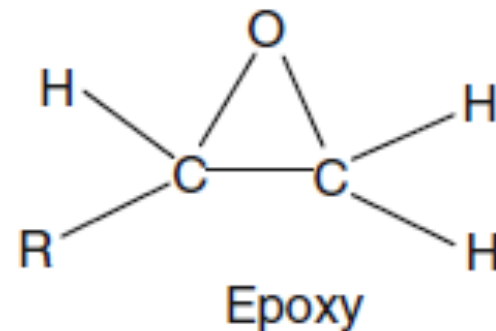
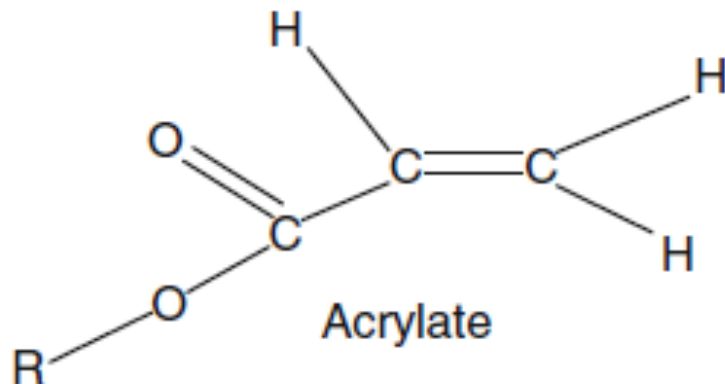

# + Polymerization

Radical  
polymerization

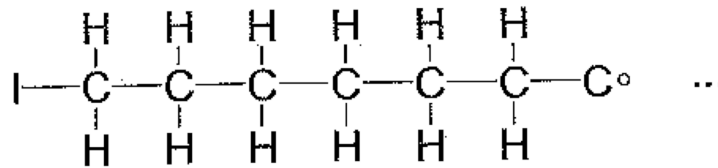
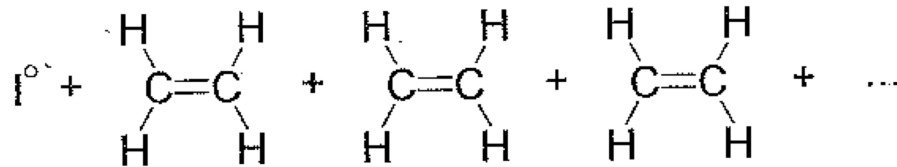

Cationic  
polymerization

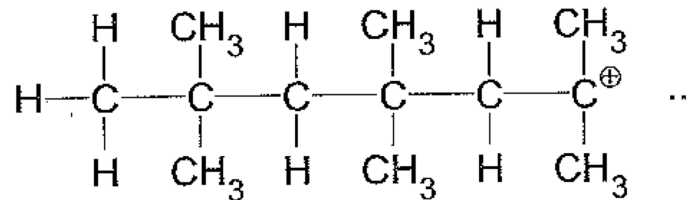
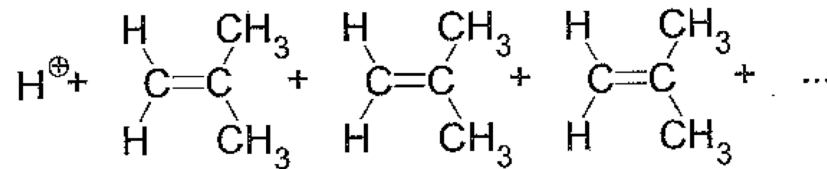

# + Photopolymerization

- Polymerization is exothermic,
- heats of reaction around 85 kJ/mol for acrylate.
- Despite high heats of reaction, a catalyst is necessary to initiate the reaction.
- A photoinitiator acts as the catalyst.
- Mixtures of different types of photoinitiators may also be employed



# + Radical polymerization



$P-I \rightarrow -I\bullet$  (free radical formation)

$I\bullet + M \rightarrow I-M\bullet$  (initiation)

$I-M\bullet \rightarrow \rightarrow I-M-M-M-M\dots-M\bullet$  (propagation)

$\rightarrow I-M-M-M-M\dots-M-I$  (termination)

- Polymerization terminates for:
  - recombination,
  - disproportionation,
  - occlusion.



# + Radical polymerization

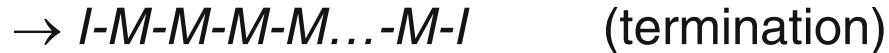

- Polymerization terminates for:
  - recombination,
  - disproportionation,
  - occlusion.

# + Radical polymerization

- Reaction rate

$$R_p = -d[\mathbf{M}]/dt \propto [\mathbf{M}] (k[\mathbf{I}])^{1/2}$$

- Average molecular weight  
(kinetic average chain length)

$$v_o = R_p/R_i \propto [\mathbf{M}]/[\mathbf{I}]^{1/2}$$



# **STEREOLITHOGRAPHY CONFIGURATIONS**

# + Stereolithography configurations

- Vector scan

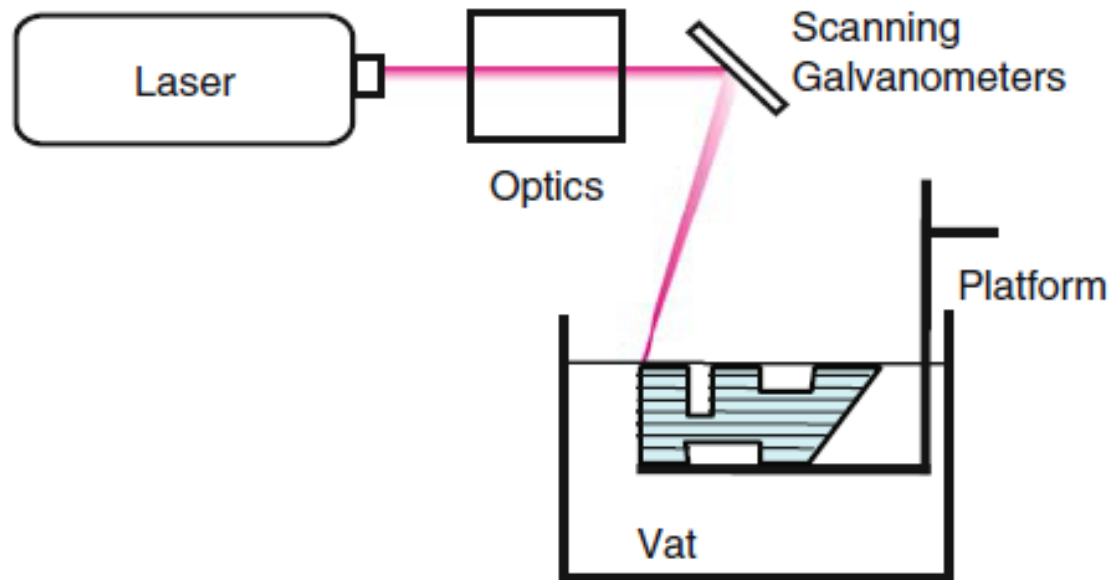

# + Stereolithography configurations

- Mask projection

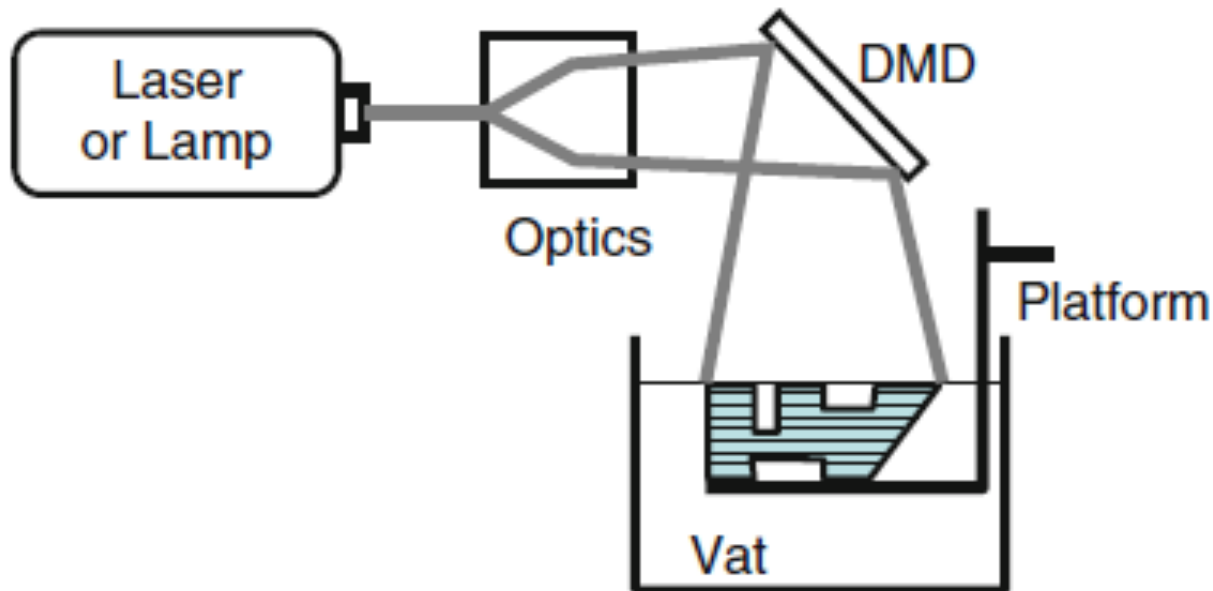

# + Stereolithography configurations

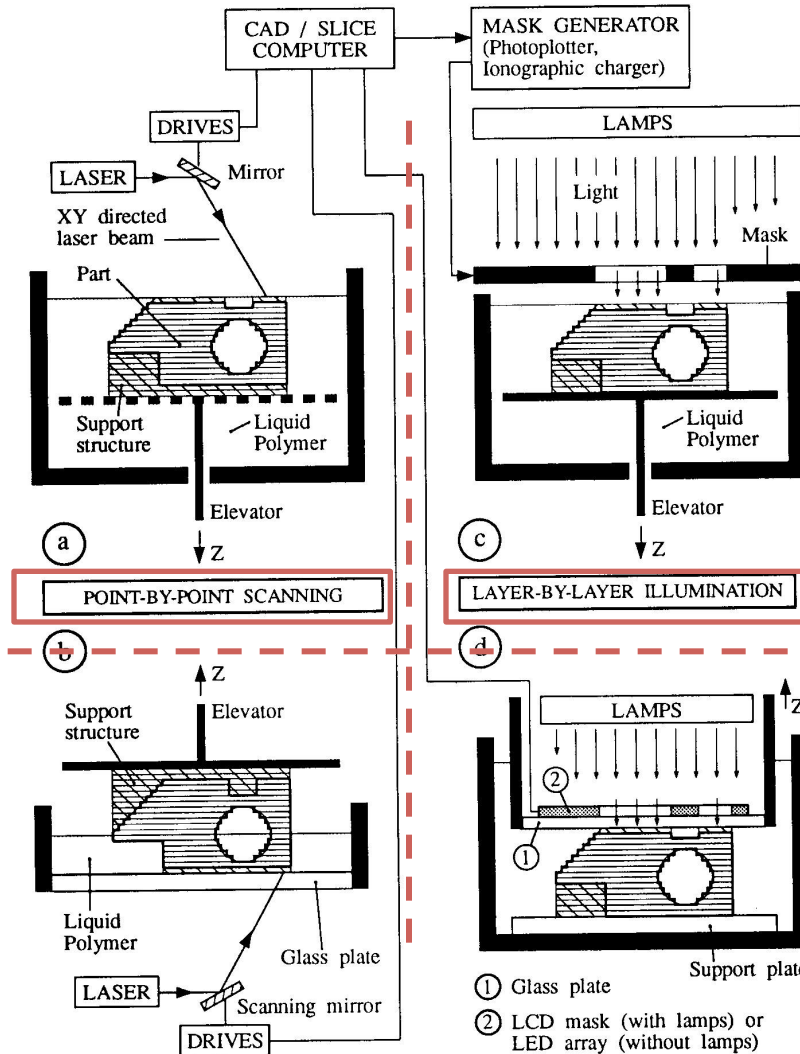

# + Stereolithography configurations

- Two photon approach

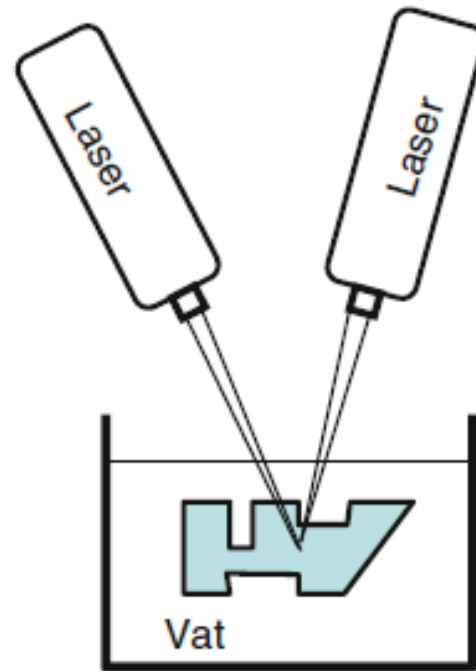

**VECTOR SCAN**



# + Stereolithography – vector or point-by-point scanning

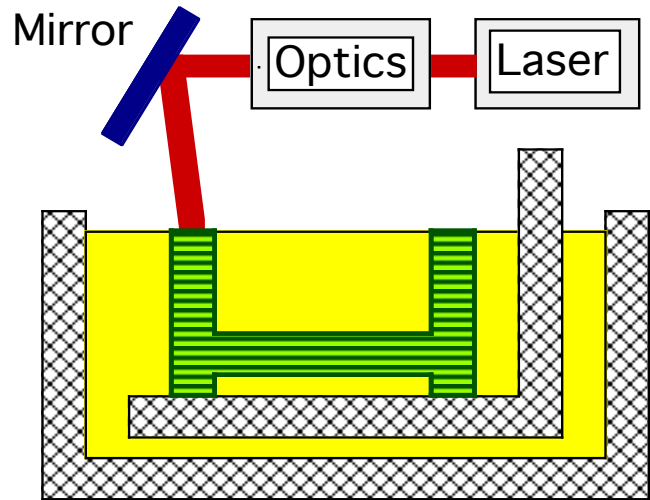

Laser is focused/shaped through optics. A computer controlled mirror directs laser to appropriate spot on photopolymer surface. Polymer solidifies wherever laser hits it.

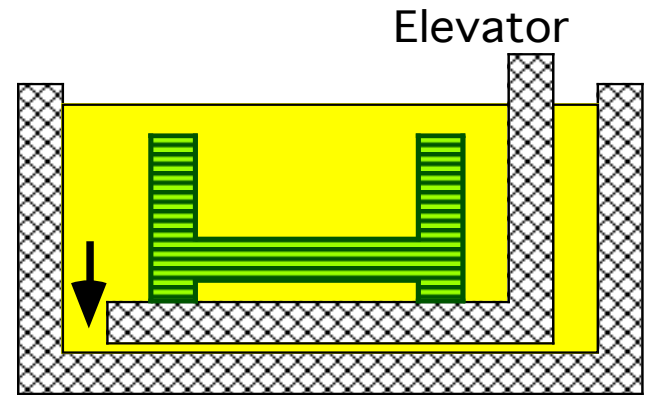

When cross section is complete, elevator indexes to prepare for next layer.

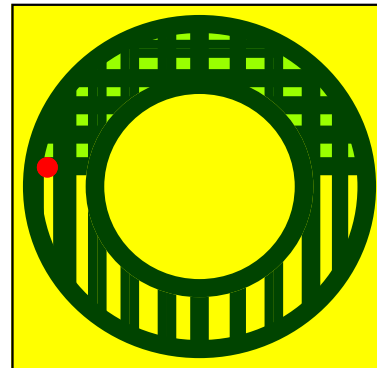

# + Stereolithography – vector or point-by-point scanning

1. Laser traces current cross section onto surface of photocurable liquid acrylate resin
  2. Polymer solidifies when struck by the laser's intense UV light
  3. Elevator lowers hardened cross section below liquid surface
  4. Laser prints the next cross section directly on top of previous
  5. After entire 3D part is formed it is post-cured (UV light)
- Note:
    - care must be taken to support any overhangs
    - The SLA modeler uses a photopolymer, which has very low viscosity until exposed to UV light. Unfortunately this photopolymer is toxic. Warpage occurs.

# + SL machine

- Machine subsystems hierarchy

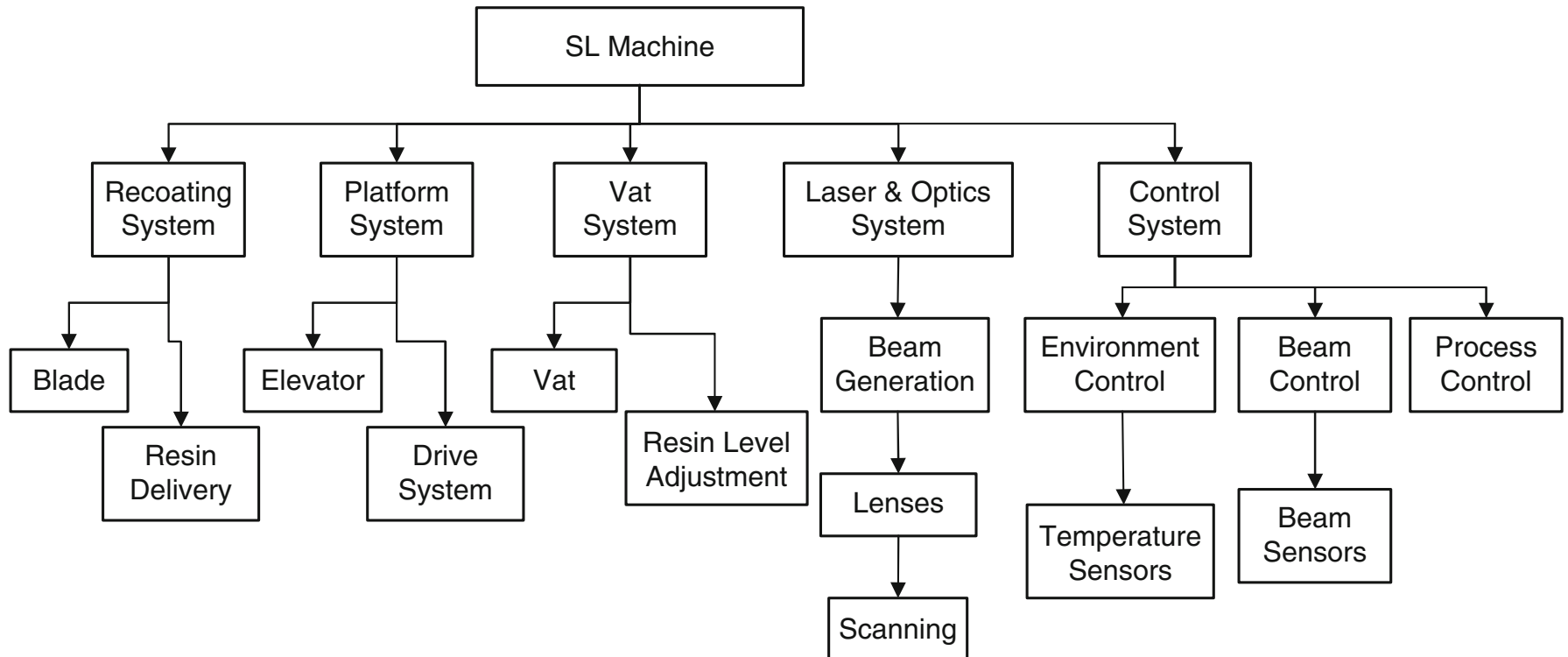

# + 3D System SLA 7000

<b>Laser</b>	He-Cd
<b>Lunghezza d'onda</b>	0.325 $\mu\text{m}$
<b>Potenza</b>	800 mW
<b>Spessore minimo</b>	0.025 mm
<b>Volume vasca</b>	253
<b>Volume di lavoro</b>	500 x 500 x 600 mm <sup>3</sup>
<b>Velocità di scansione</b>	Max 9.52 m/s
<b>Diametro Spot</b>	Da 0.23 a 0.84 mm

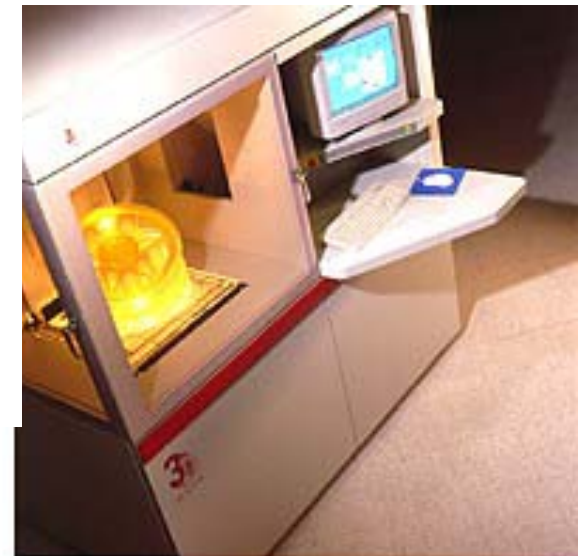

# **PROCESS PARAMETERS**

# + Nomenclature

- $C_d$  = cure depth = depth of resin cure as a result of laser irradiation [mm]
- $D_p$  = depth of penetration of laser into a resin until a reduction in irradiance of  $1/e$  is reached = key resin characteristic [mm]
- $E$  = exposure, possibly as a function of spatial coordinates [energy/unit area][mJ/mm<sup>2</sup>]
- $E_c$  = critical exposure = exposure at which resin solidification starts to occur [mJ/mm<sup>2</sup>]
- $E_{max}$  = peak exposure of laser shining on the resin surface (center of laser spot) [mJ/mm<sup>2</sup>]
- $H(x,y,z)$  = irradiance (radiant power per unit area) at an arbitrary point in the resin = time derivative of  $E(x,y,z)$  [W/mm<sup>2</sup>]
- $P_L$  = output power of laser [W]
- $V_s$  = scan speed of laser [mm/s]
- $W_0$  = radius of laser beam focused on the resin surface [mm]

# + Scan line of a Gaussian Laser

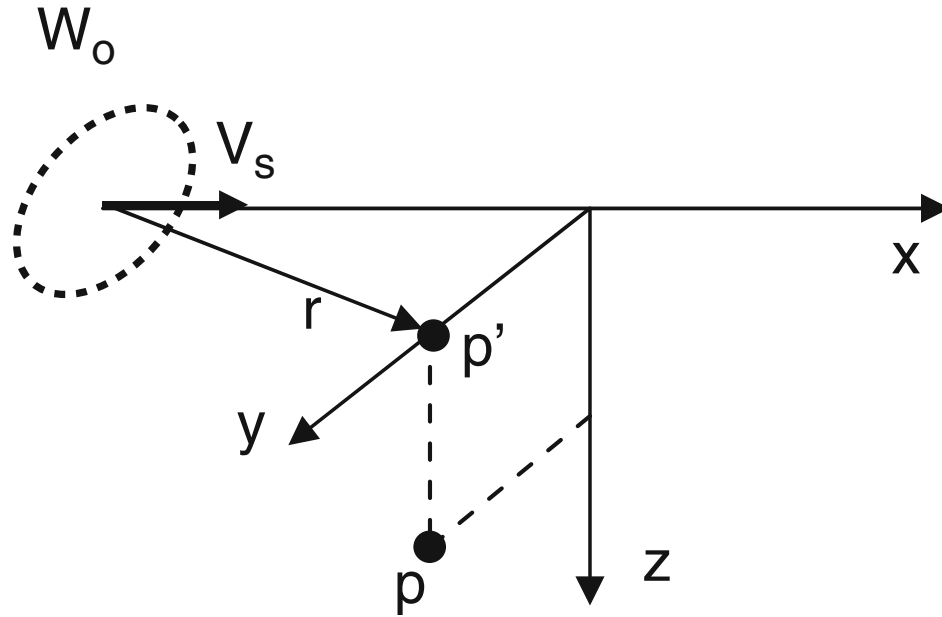

# + Scan line of a Gaussian laser

- Fundamental general exposure equation

$$E(x, y, z) = \sqrt{\frac{2}{\pi}} \frac{P_L}{W_0 V_s} e^{-2y^2 / W_0^2} e^{-z / D_p}$$



# + Scan line of a gaussian laser

- Final shape

$$2 \frac{y^{*2}}{W_0^2} + \frac{z^*}{D_p} = \ln \left[ \sqrt{\frac{2}{\pi}} \frac{P_L}{W_0 V_s E_c} \right]$$

$$C_d = D_p \ln \left[ \sqrt{\frac{2}{\pi}} \frac{P_L}{W_0 V_s E_c} \right]$$

$$L_w = W_0 \sqrt{2C_d / D_p}$$

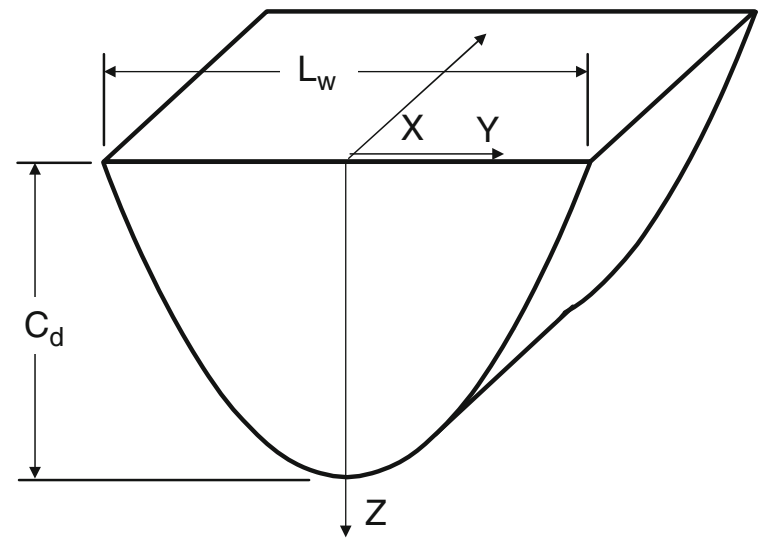

# + Scan line of a Gaussian Laser

- The line width is proportional to the beam spot size.
- If a greater cure depth is desired, line width must increase, all else remaining the same.

$$C_d = D_p \ln \left[ \sqrt{\frac{2}{\pi}} \frac{P_L}{W_0 V_s E_c} \right]$$

$$L_w = W_0 \sqrt{2C_d / D_p}$$

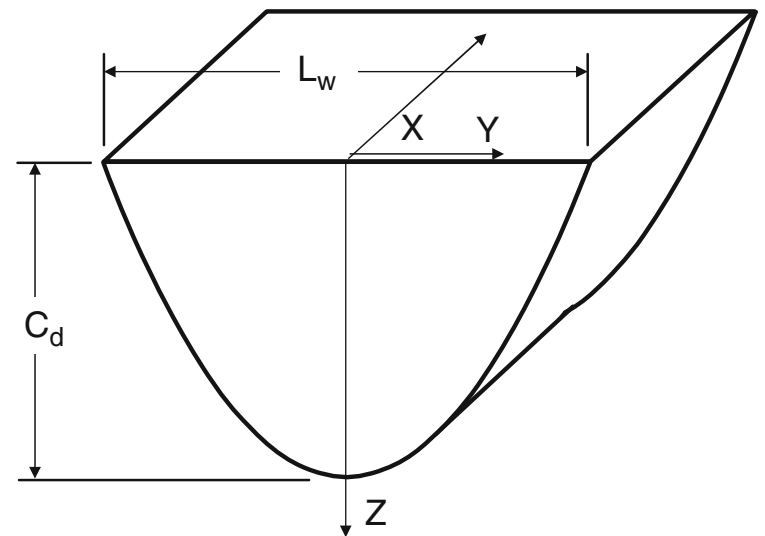

# + Working curve

$$E(0, 0) \equiv E_{\max} = \sqrt{\frac{2}{\pi}} \frac{P_L}{W_0 V_s}$$

$$C_d = D_p \ln \left( \frac{E_{\max}}{E_c} \right)$$

$$C_d = D_p \ln \left[ \sqrt{\frac{2}{\pi}} \frac{P_L}{W_0 V_s E_c} \right]$$

$$V_s = \sqrt{\frac{2}{\pi}} \frac{P_L}{W_0 E_c} e^{-C_d/D_p}$$

$$L_w = W_0 \sqrt{2C_d/D_p}$$

# + Working curve

- The cure depth is proportional to the natural logarithm of the maximum exposure on the centerline of a scanned laser beam.
- A semilog plot of  $C_d$  vs.  $E_{max}$  should be a straight line. This plot is known as the working curve for a given resin.
- The slope of the working curve is precisely  $D_p$  at the laser wavelength being used to generate the working curve.
- The x-axis intercept of the working curve is  $E_c$ , the critical exposure of the resin at that wavelength. Theoretically, the cure depth is 0 at  $E_c$ , but this does indicate the gel point of the resin.
- Since  $D_p$  and  $E_c$  are purely resin parameters, the slope and intercept of the working curve are independent of laser power.
- In practice, various  $E_{max}$  values can be generated easily by varying the laser scan speed

# + Working curve

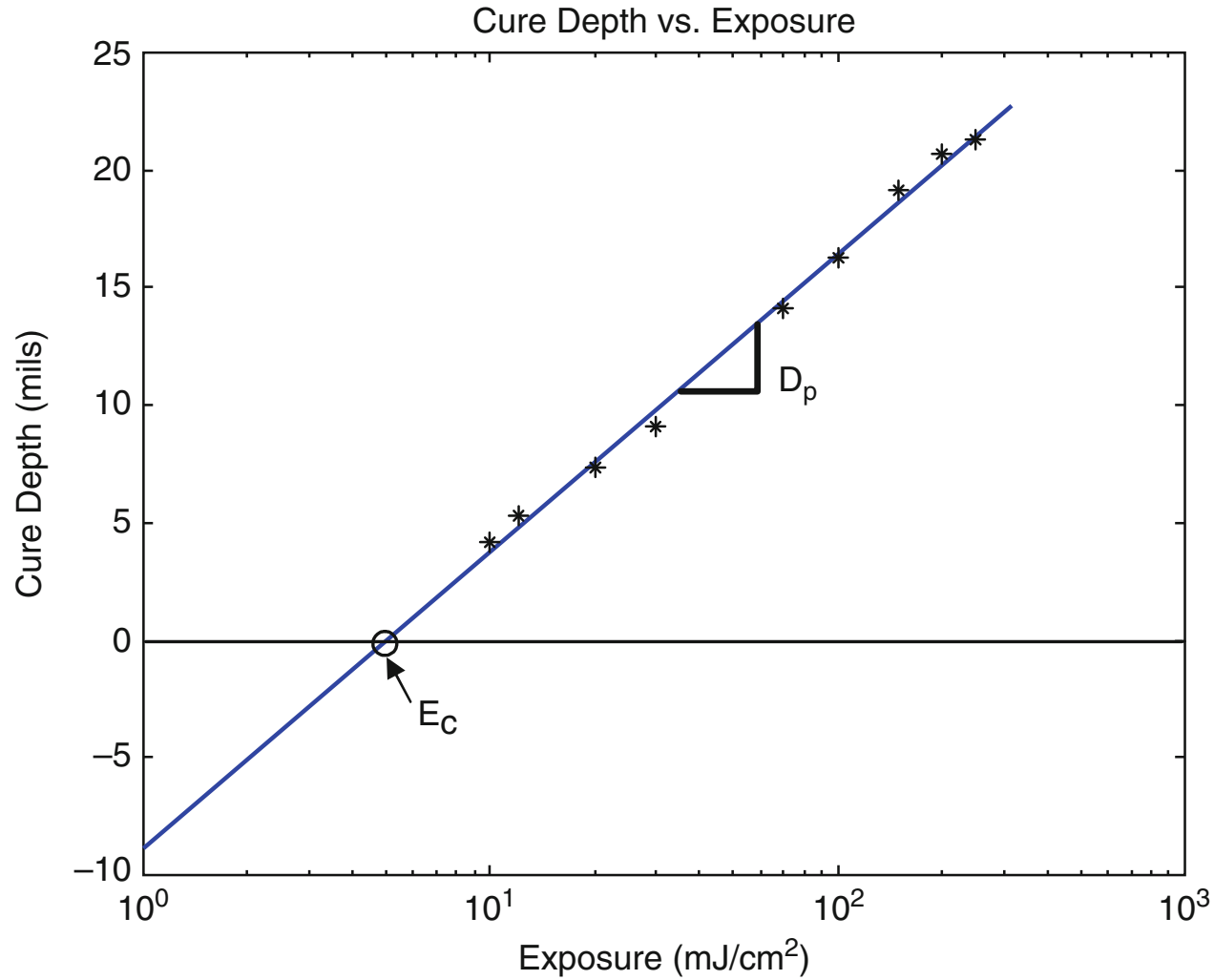

# + Materials: Somos 18120



## TECHNICAL DATA - LIQUID PROPERTIES

Appearance	Translucent
Viscosity	~300 cps @ 30°C
Density	~1.16 g/cm <sup>3</sup> @ 25°C

## TECHNICAL DATA - OPTICAL PROPERTIES

E <sub>c</sub>	6.73 mJ/cm <sup>2</sup>	[critical exposure]
D <sub>p</sub>	4.57 mils	[slope of cure-depth vs. ln (E) curve]
E <sub>10</sub>	57.0 mJ/cm <sup>2</sup>	[exposure that gives 0.254 mm (.010 inch) thickness]

# + Materials: Somos 18120



TECHNICAL DATA							
Mechanical Properties		Somos® ProtoGen 18120 UV Postcure at HOC -2		Somos® ProtoGen 18120 UV Postcure at HOC +3		Somos® ProtoGen 18120 UV & Thermal Postcure	
ASTM Method	Property Description	Metric	Imperial	Metric	Imperial	Metric	Imperial
D638M	Tensile Strength	51.7 - 54.9 MPa	7.5 - 8.0 ksi	56.9 - 57.1 MPa	8.2 - 8.3 ksi	68.8 - 69.2 MPa	9.9 - 10.0 ksi
D638M	Tensile Modulus	2,620 - 2,740 MPa	381 - 397 ksi	2,540 - 2,620 MPa	370 - 380 ksi	2,910 - 2,990 MPa	422 - 433 ksi
D638M	Elongation at Break	6 - 12%	6 - 12%	8 - 12%	8 - 12%	7 - 8%	7 - 8%
D638M	Poisson's Ratio	0.43 - 0.45	0.43 - 0.45	N/A	N/A	0.43	0.43
D790M	Flexural Strength	81.8 - 83.8 MPa	11.9 - 12.2 ksi	83.8 - 86.7 MPa	12.2 - 12.6 ksi	88.5 - 91.5 MPa	13.2 ksi
D790M	Flexural Modulus	2,360 - 2,480 MPa	343 - 359 ksi	2,400 - 2,450 MPa	350 - 355 ksi	2,330 - 2,490 MPa	361 ksi
D2240	Hardness (Shore D)	84 - 85	85 - 87	N/A	N/A	87 - 88	87 - 88
D256A	Izod Impact (Notched)	0.14 - 0.26 J/m	0.26 - 0.49 ft-lb/in	N/A	N/A	0.13 - 0.25 J/m	0.24 - 0.47 ft-lb/in
D570-98	Water Absorption	0.77%	0.77%	N/A	N/A	0.75%	0.75%

# + Materials cont:

- **SLA Somos 7120** - A high speed general use resin that is heat and humidity resistant.
- **Somos 9120** - A robust accurate resin for functional parts. For more information on this material please read the material
- **Somos 9920** - A durable resin whose properties mimic polypropylene. Offers superior chemical resistance, fatigue properties, and strong memory retention.
- **Somos 10120 WaterClear** - A general purpose resin with mid range mechanical properties. Transparent parts are possible if finished properly.
- **Somos 11120 WaterShed** - Produces strong, tough, water-resistant parts. Many of its mechanical properties mimic that of ABS plastic.
- **Somos 14120 White** - A low viscosity liquid photopolymer that produces strong, tough, water-resistant parts.
- **Somos ProtoTool** - ProtoTool is a high density material that transcends currently available stereolithography resins by offering superior modulus and temperature resistance.



# + Time scales

- Laser travel  $10^{-12}$ s
- Photopolimer reaction  $10^{-6}$ s
- Exposure time 50-2000  $10^{-6}$ s
- Onset shrinkage 0.4-1 s
- Completion shrinkage 4-10s
- Layer scanning 10-300 s



# + Scanning strategie

- Joining the current layer with the previous one
- Residual stresses
- Extra energy (print through errors)
- Various scanning strategies
  - WEAVE
  - STARWEAVE
  - ACES scan pattern



# + ACES scan pattern

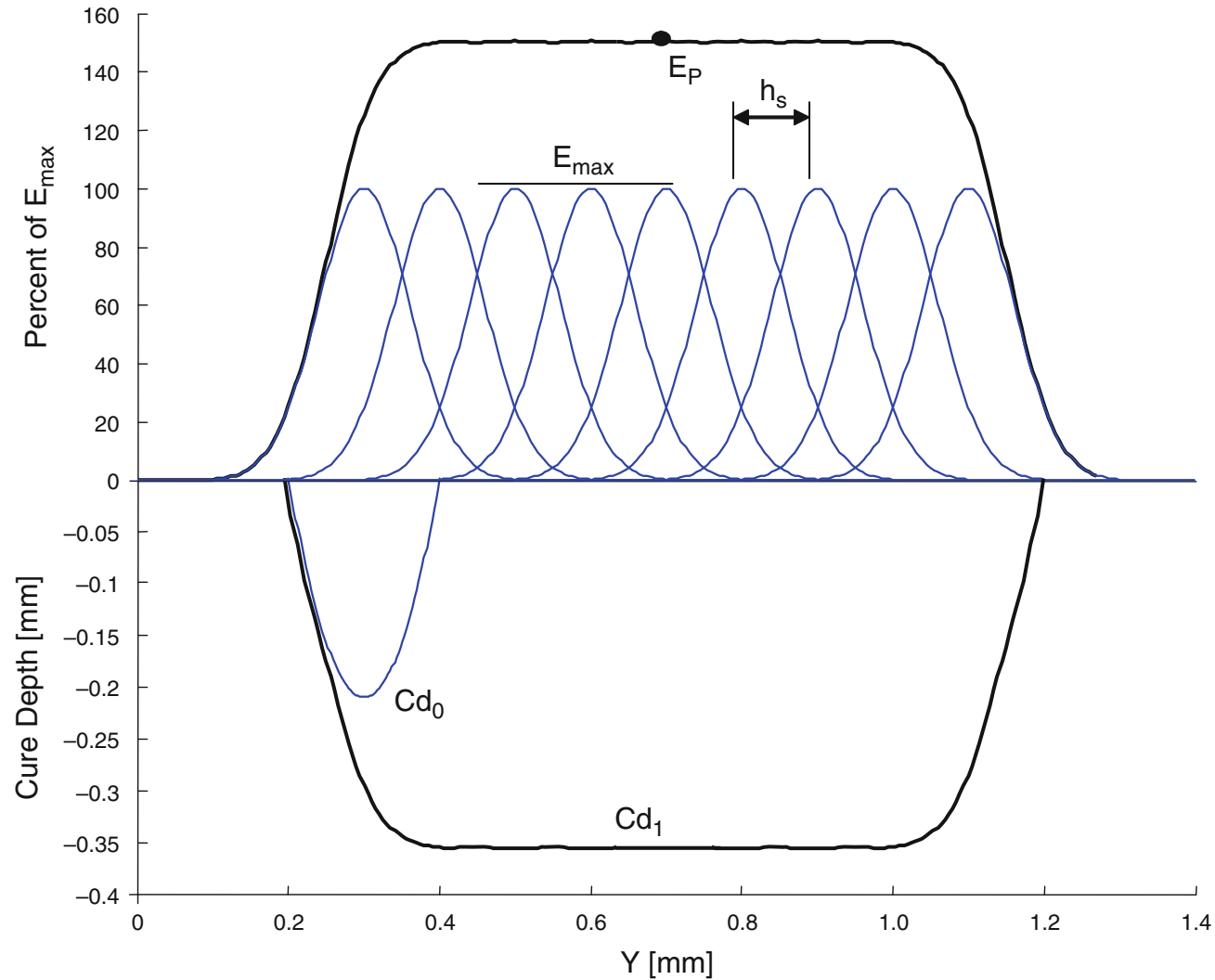

**MASK PROJECTION**

# + Layer at a Time Solidification (Mask)

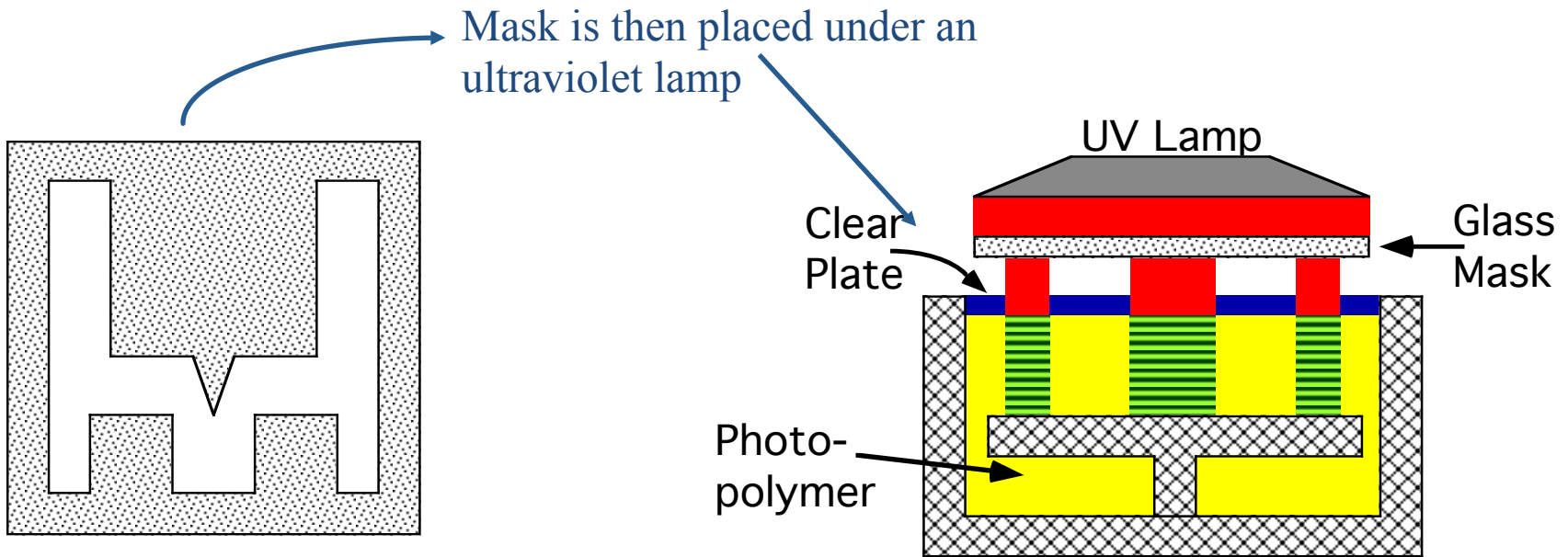

A glass mask is generated

Laser then shines through mask, solidifying the entire layer in one “shot.” More rapid layer formation, and thorough solidification.

# + Layer at a Time Solidification (DMD)

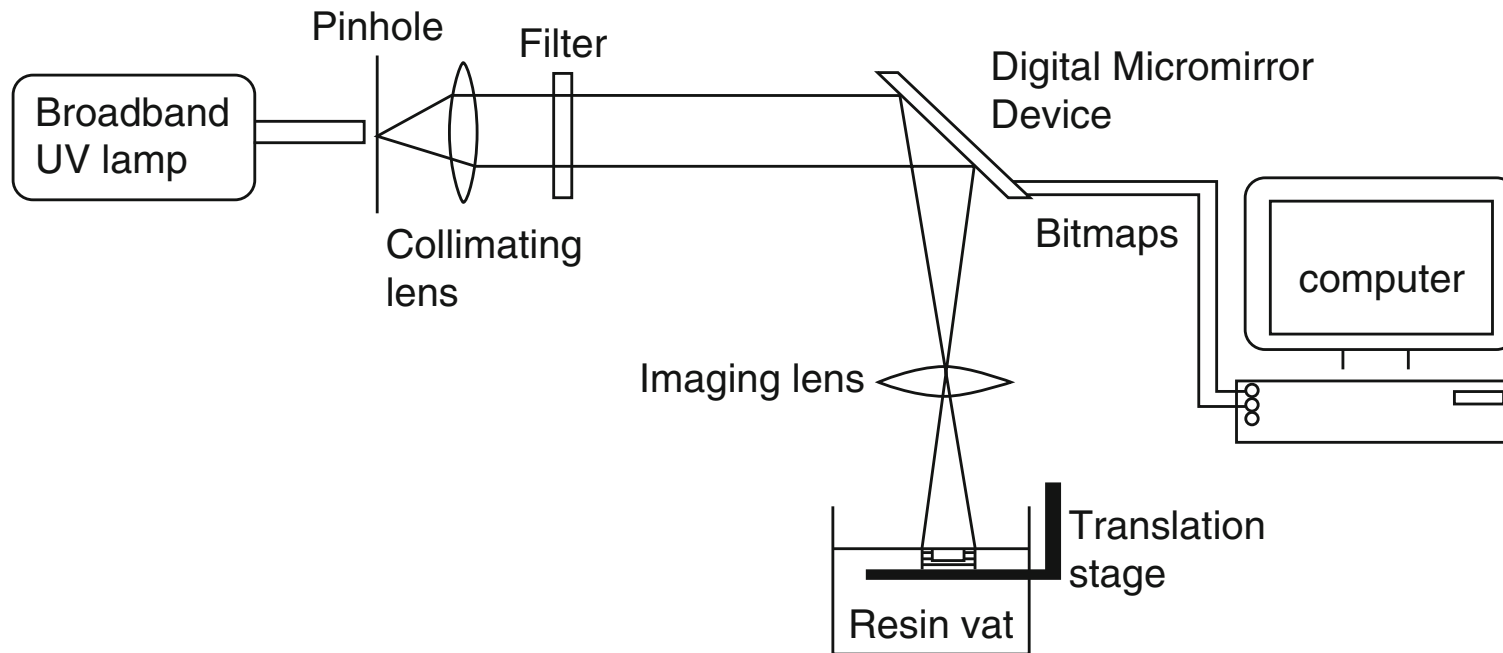

# + Photosolidification Layer at a Time

1. Cross section shape is “printed” onto a glass mask
2. Glass mask is positioned above photopolymer tank
3. Another rigid glass plate constrains liquid photopolymer from above
4. UV lamp shines through mask onto photopolymer- light only can pass through clear part, polymer solidifies there, polymer in masked areas remains liquid
5. Due to contact with glass plate, the cross linking capabilities of the photopolymer are preserved- bonds better w/ next layer
6. New coat of photopolymer is applied
7. New mask is generated and positioned, and process repeats
8. 12-15 minute postcure is required

## Note:

1. Much less warpage than SLA, but still uses photopolymers which are toxic.



# Exposure consideration

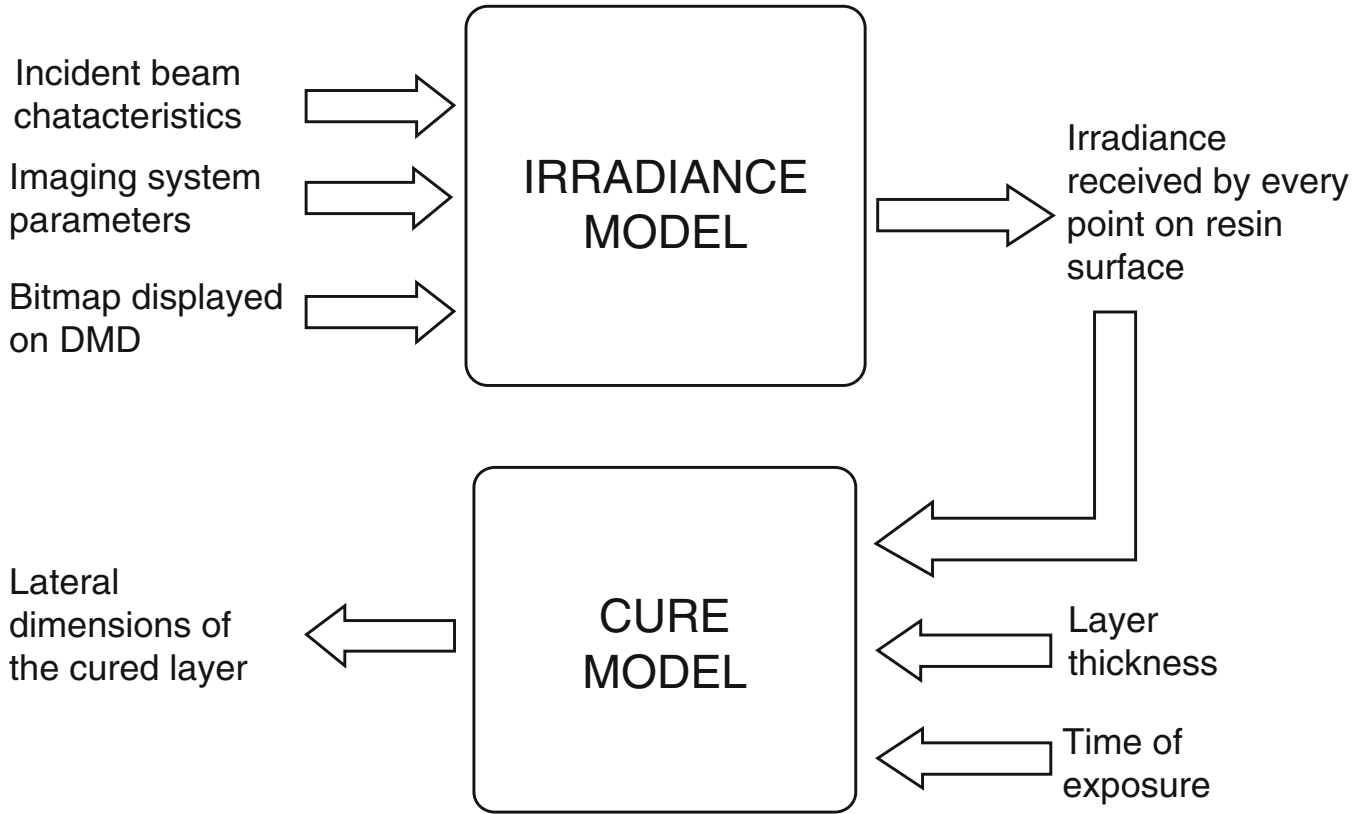

$$C_d = D_p e^{-E/E_c} = D_p e^{-H \cdot T/E_c}$$



# + Commercial system



**Table 4.3** Specifications on EnvisionTEC Perfactory Standard Zoom machine

Lens system		$f = 25\text{--}45 \text{ mm}$
Build envelope	Standard	$190 \times 142 \times 230 \text{ mm}$
	High resolution	$120 \times 90 \times 230 \text{ mm}$
Pixel size	Standard	$86\text{--}136 \mu\text{m}$
	High resolution	$43\text{--}68 \mu\text{m}$
Layer thickness	$25\text{--}150 \text{ mm}$	

# **GENERAL CONSIDERATION**



# Cost



- Cost of materials:
  - 200€ per liter
  - A cube  $20*20*20 \text{ cm}^3$  approx 8 liters
- Post processing Requirements:
  - Careful practices are required to work with the resins.
  - Frameworks must be removed from the finished part.
  - Alcohol baths then Ultraviolet ovens are used to clean and cure the parts.

## + Pros

- Probably the most accurate functional prototyping on the market.
  - Layer thickness (from 20 to 150  $\mu\text{m}$ )
  - Minimum feature size 80 to 300  $\mu\text{m}$
  - Smooth surface finish, high dimensional tolerance, and finely detailed features (thin-walls, sharp corners, etc...)
- Large build volume
  - Up to 50 x 50 x 60  $\text{cm}^3$  (approx)
- Used in: Investment Casting, Wind Tunnels, and Injection Molding as tooling
- Resins can be custom engineered to meet different needs: higher-temps, speed, finish...



# + Cons

- Requires post-curing.
- Long-term curing can lead to warping.
- Parts are quite brittle and have a tacky surface.
- Support structures are typically required.
  - Supports must be removed by hand
- Uncured material is toxic.
- Little material choice
- Costs
  - Material
  - trained operator
  - Lab environment necessary (gasses!)
  - Laser lasts 2000hrs, costs \$20' 000!
- Slow process





# Link utili



- [http://www.acucast.com/rapid\\_prototyping.htm](http://www.acucast.com/rapid_prototyping.htm)
- <http://www.milparts.net/sla.html>
- <http://www.protocam.com/html/materials-sla.html>
- <http://www.3dsystems.com>
- [http://www.dsm.com/products/somos/en\\_US/offerings/offerings-somos-proto-gen.html#](http://www.dsm.com/products/somos/en_US/offerings/offerings-somos-proto-gen.html#)

“Layerless 3D printing”

**CARBON 3D**

# + Carbon 3D

## Continuous Liquid Interface Production

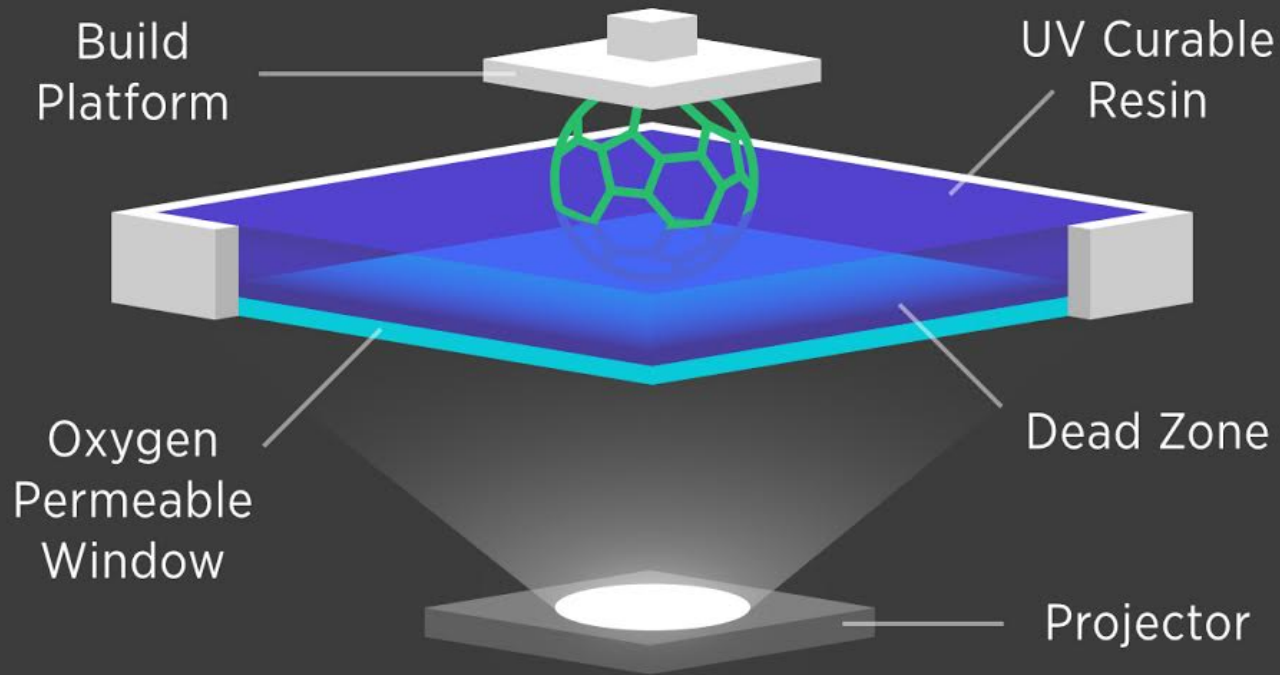



# + Carbon 3D

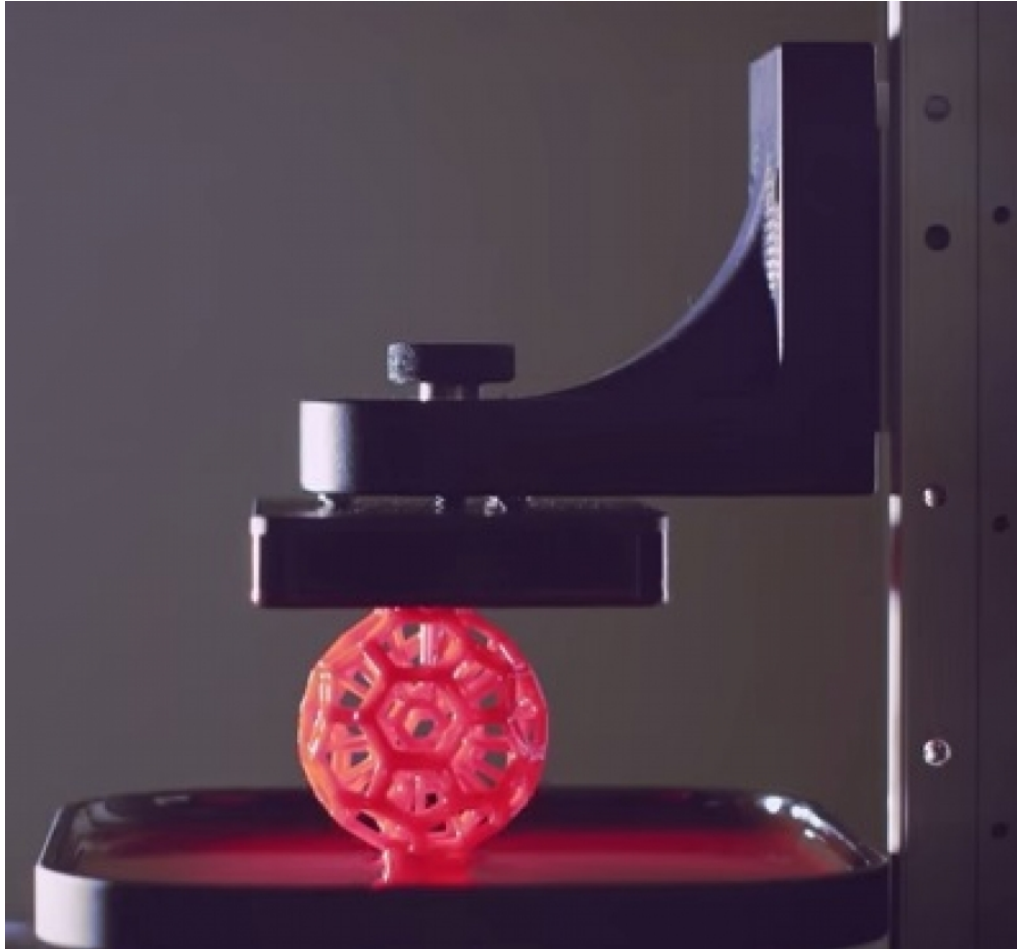

# **TWO PHOTON STEREOLITHOGRAPHY**

# + Two photon stereolithography

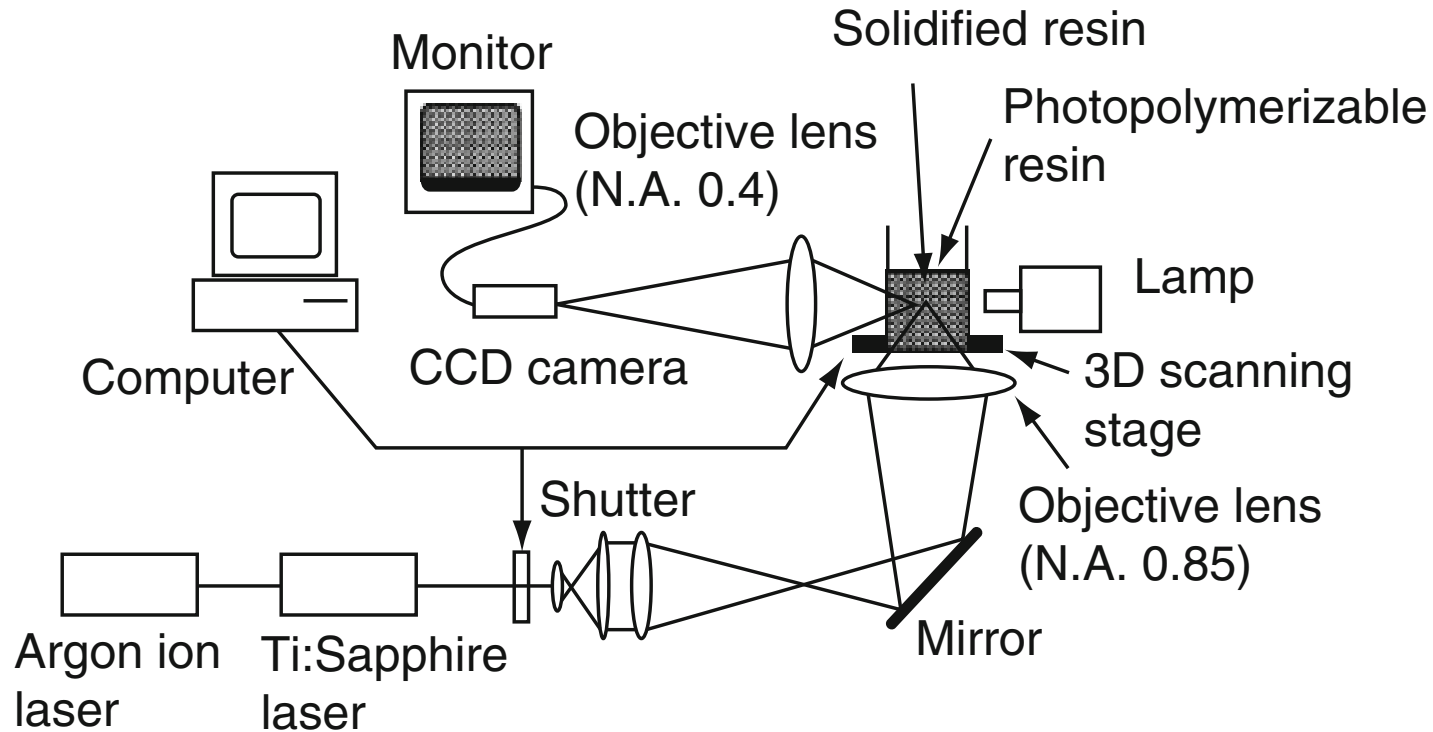

# + Two photon stereolithography

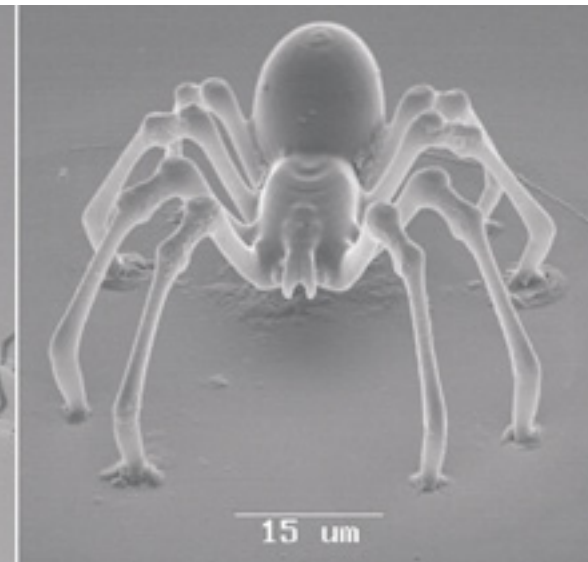
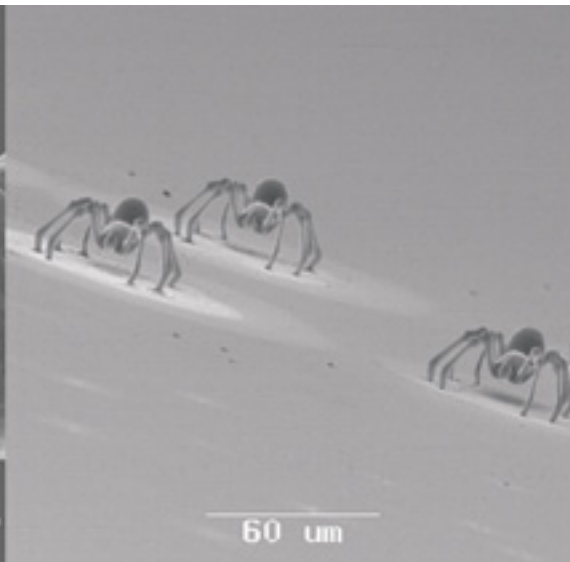
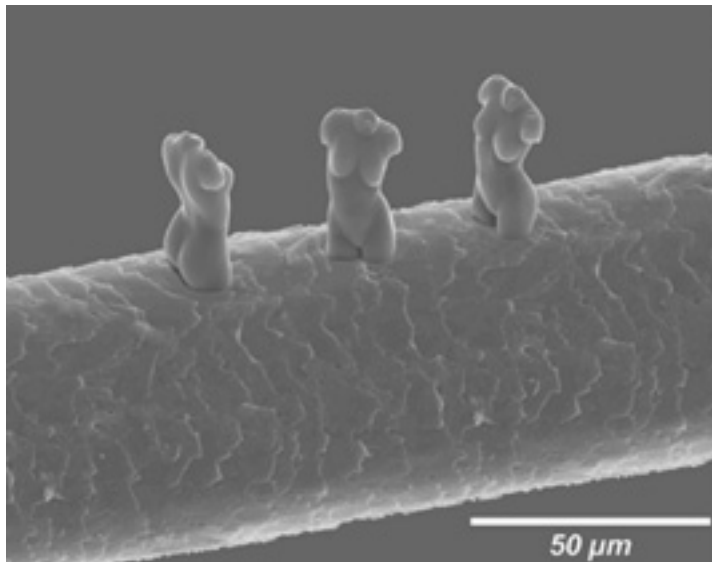
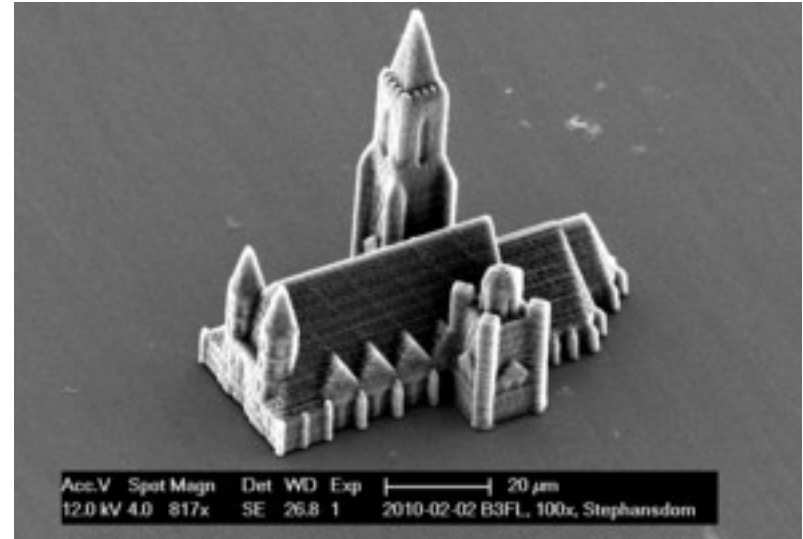
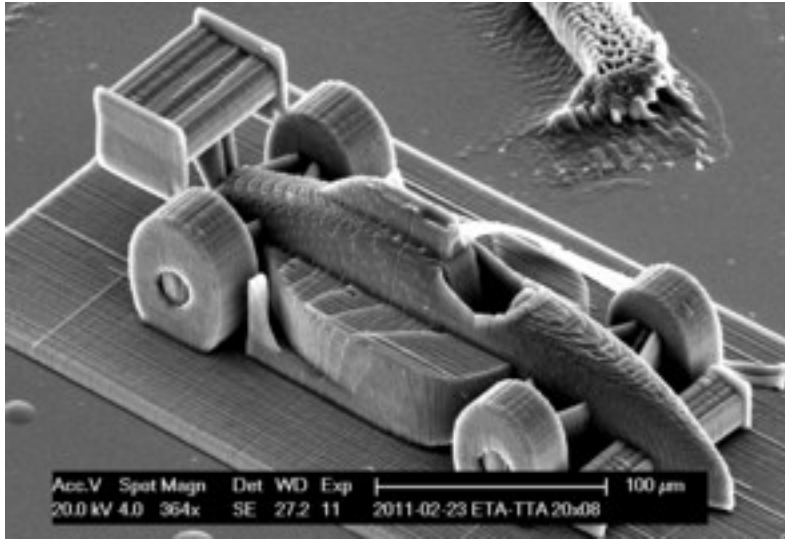

# + Two photon stereolithography

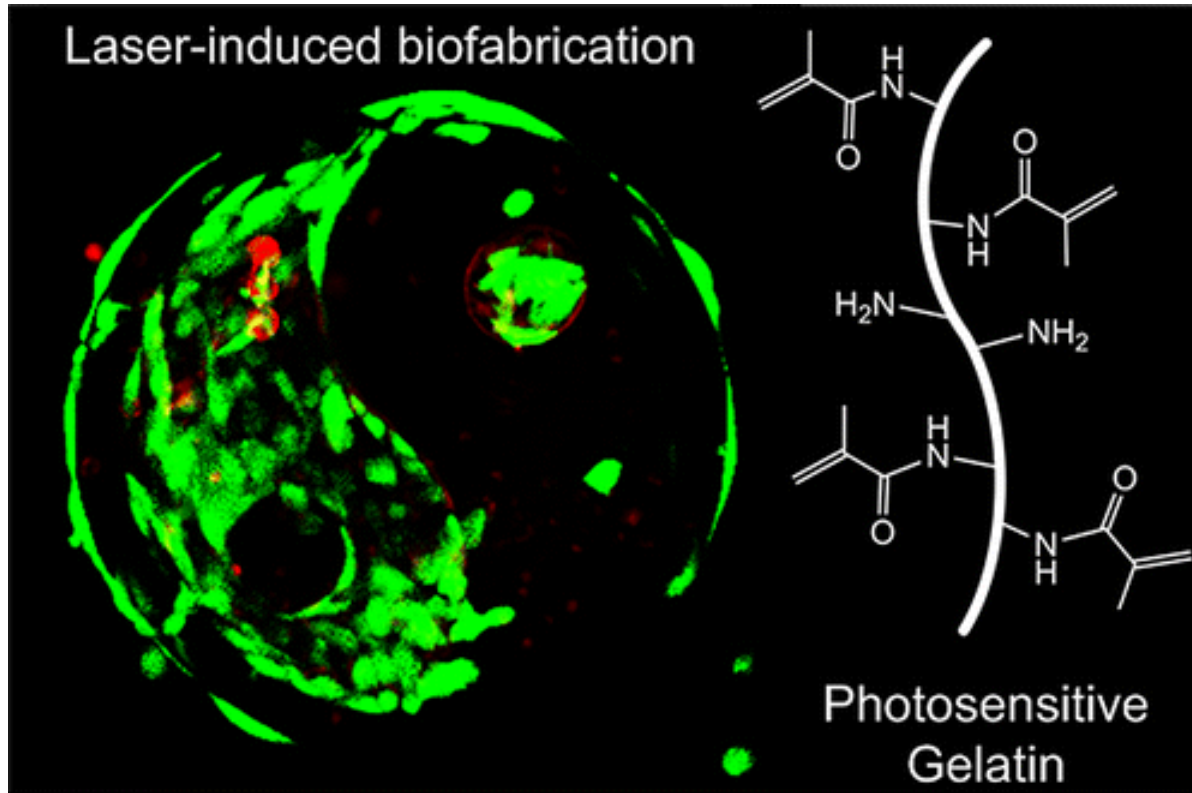

**SOLID GROUND CURING**

# + Solid Ground Curing (SGC)

- **Solid Ground Curing (SGC)**, is somewhat similar to stereolithography (SLA)
- both use ultraviolet light to selectively harden photosensitive polymers.
- SGC cures an entire layer at a time and use another material as support



# + Solid Ground Curing (SGC)

1. Photosensitive resin is sprayed on the build platform.
2. The machine develops a photomask (like a stencil) of the layer to be built.
3. This photomask is printed on a glass plate above the build platform using an electrostatic process similar to that found in photocopiers.
4. The mask is then exposed to UV light, which only passes through the transparent portions of the mask to selectively harden the shape of the current layer.
5. After the layer is cured, the machine vacuums up the excess liquid resin and sprays wax in its place to support the model during the build.
6. The top surface is milled flat, and then the process repeats to build the next layer.
7. When the part is complete, it must be de-waxed by immersing it in a solvent bath.



# + Solid Ground Curing

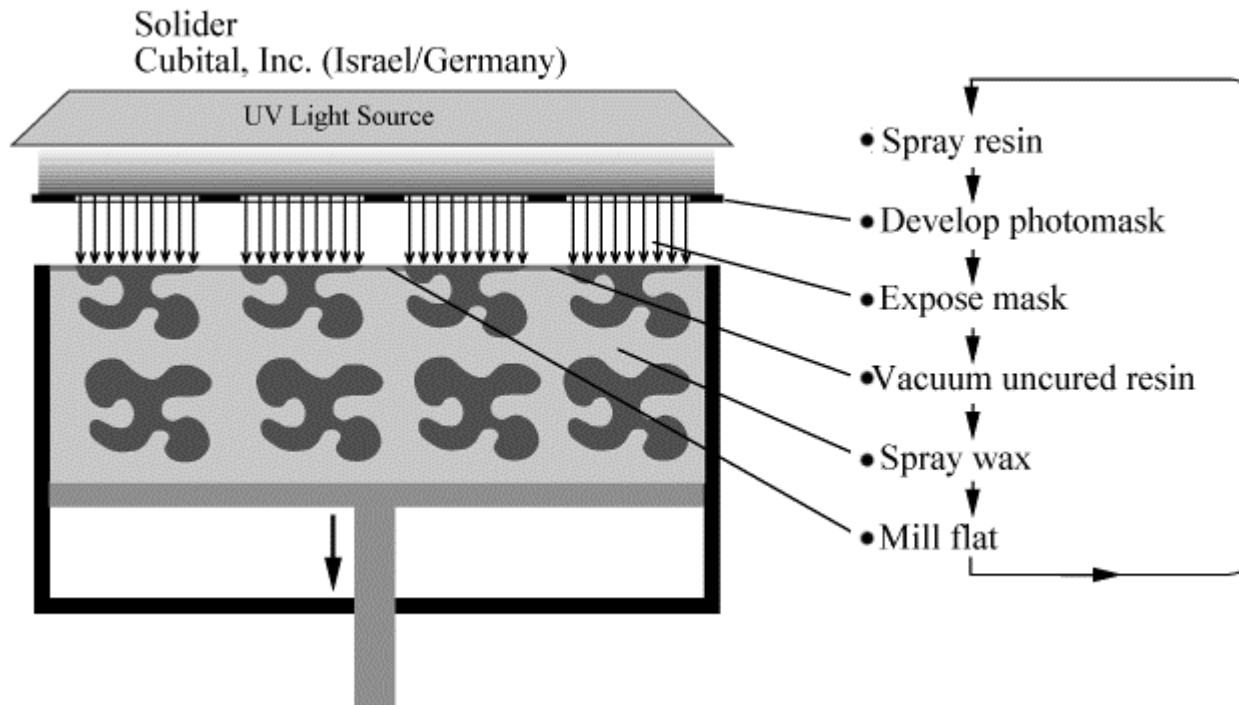

# + Solid Ground Curing

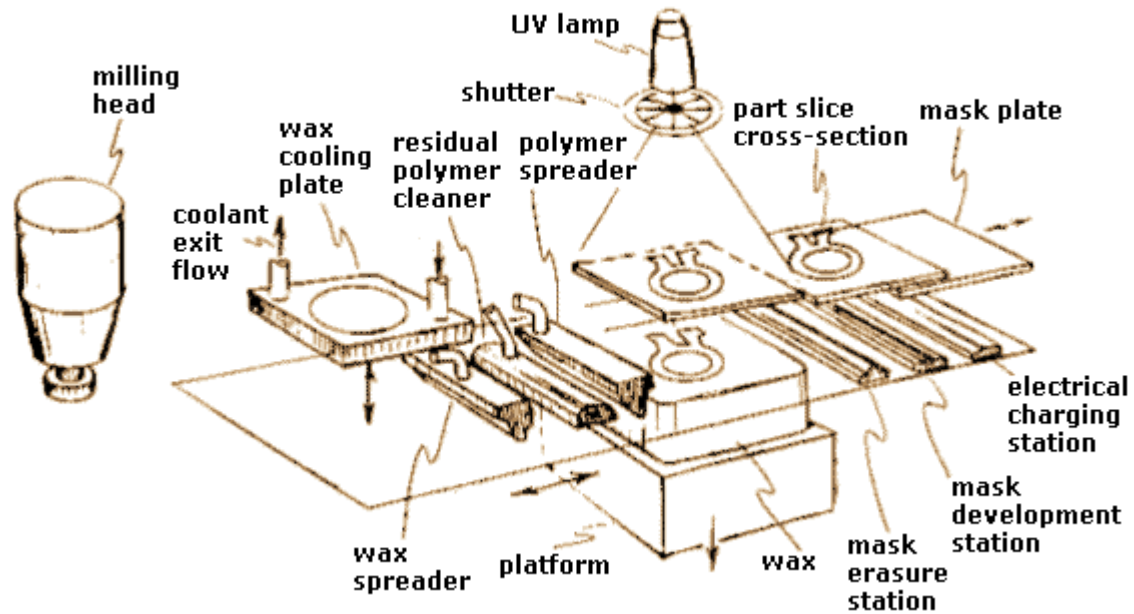

# + Solid Ground Curing

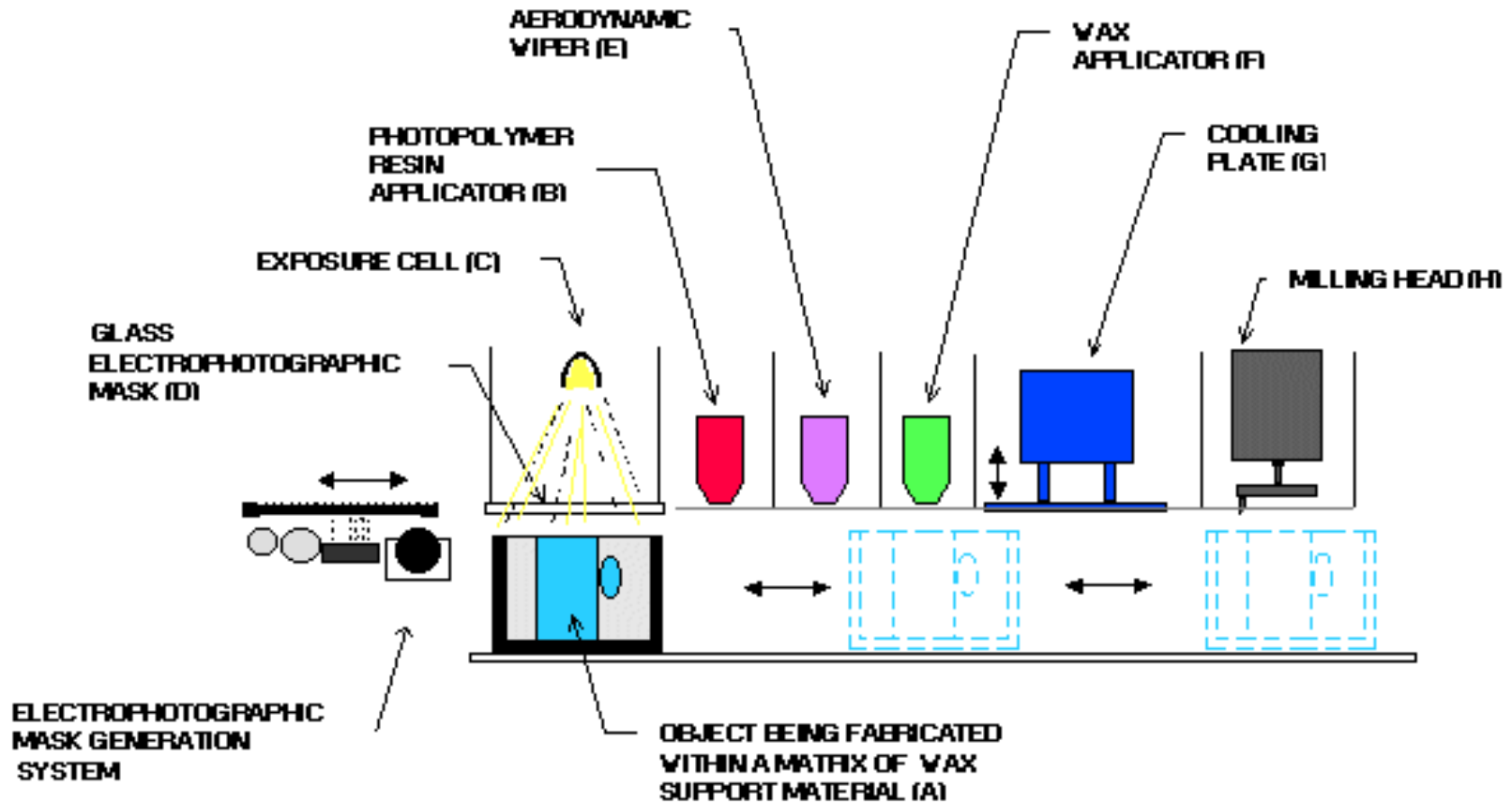

# + Solid Ground Curing

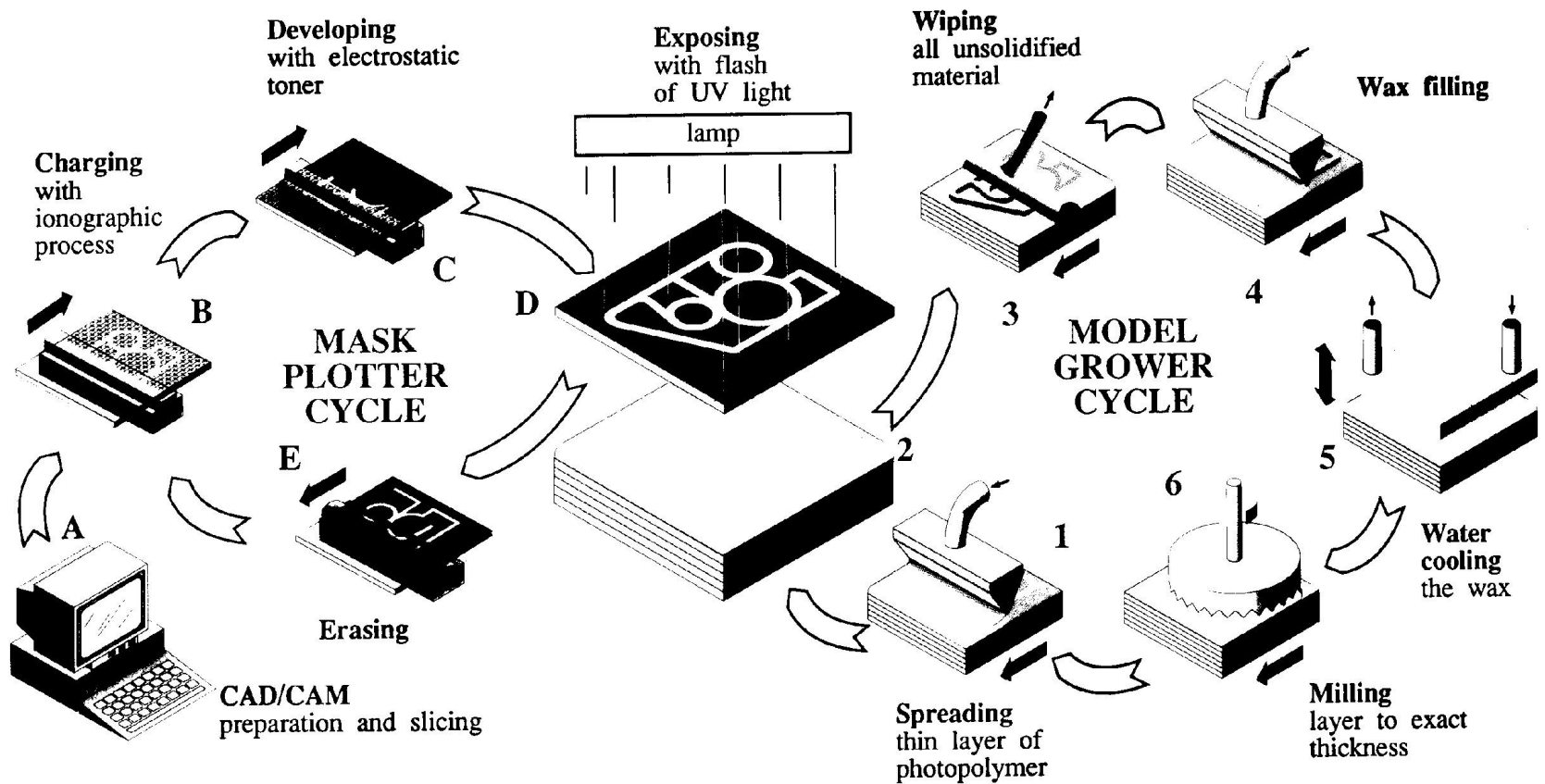

# + Solid Ground Curing

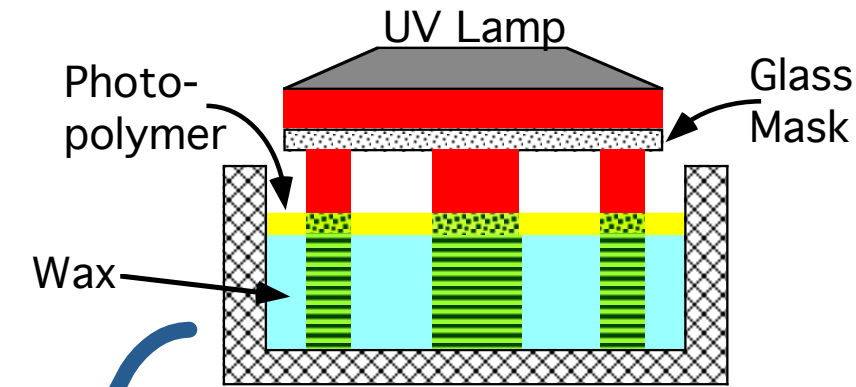

Shine UV Lamp through mask to solidify photopolymer

Generate glass mask

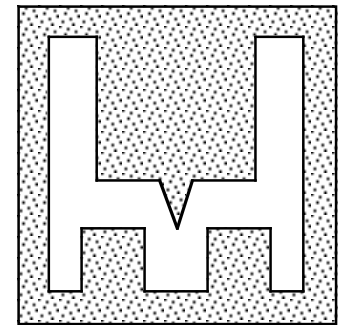

Remove excess polymer, and fill gaps with liquid wax. Chill to solidify wax.

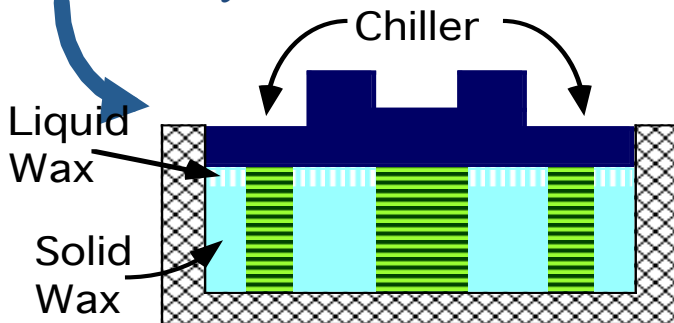

Coat with photopolymer

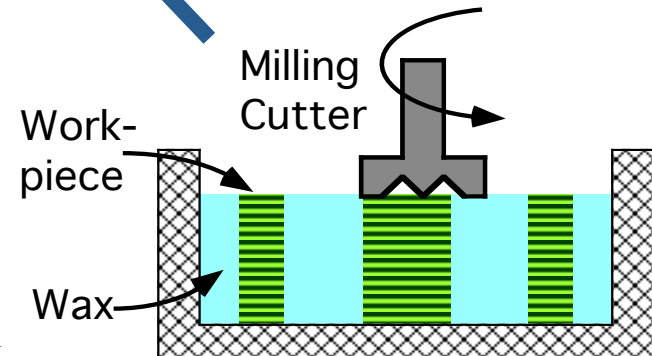

Mill wax & workpiece

## + **SGC: pros and cons**

- High capital and operational cost
- Large heavy equipment
- Good dimensional accuracy
- Much less warpage than SLA



# **EXERCISES**

# + Esercizi

D: Sulla base della seguente tabella, stimare la tecnologia più conveniente per realizzare 50 dadi da gioco

\*incluso costo operatore e tempo utilizzo macchina,

\*\*incluso il costo della progettazione dell'oggetto, e della generazione di eventuali file CAM; escluso costo acquisto macchina

Tecnologia	Costo materiale (€/cm <sup>3</sup> )	Costo per pezzo (€)*	Costo attrezzatura (€)**
Fresatura CNC	0.1	15	40
SLA	1	10	10
FDM	0.1	5	5
SLS	2	15	20
Injection molding	0.01	0.05	15000





I seguenti screenshot si riferiscono alla fabbricazione di un cubo di 5 cm di lato in ABS utilizzando la tecnologia FDM. L'estrusore ha un diametro di 0.4 mm.

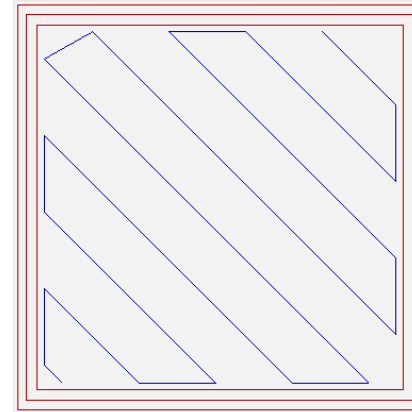
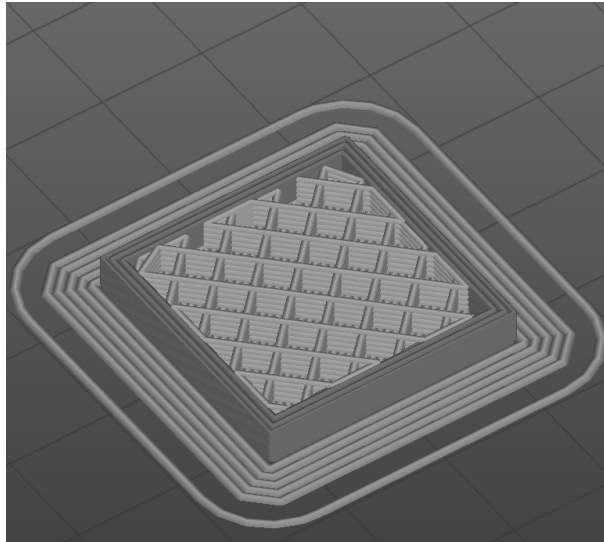

Parametro	Valore		
	SI		No
Platform adhesion type (Brim)			
Layer thickness (mm)			
Shell thickness (mm)			
Fill density (%)	20%	50 %	70%
Top/bottom thickness (mm)			
Print speed (mm/s)			
Printing temperature (°C)			
Filament diameter (mm)			

