

Esercitazione 8/03

<i>Gruppo</i>	1	2	3	4	5	6	7	8	9	10	11
Domanda 1	ok	ok	ok	ok-	ok-	ok+	ok+	ok	ok+	ok-	ok
Domanda 2	ok+	ok	ok	ok	ok	ok	ok+	ok	ok+	ok	ok
Domanda 3	ok	ok+	ok	ok	ok	ok	ok+	ok	ok	ok+	ok+

Esercitazioni

<i>Gruppo</i>	1	2	3	4	5	6	7	8	9	10	11
1.03 Proprietà Materiali	ok	ok	ok	ok	ok	ok	ok	ok	ok	ok	ok
8.03 Polymers&Hydrogels	ok	ok	ok	ok	ok	ok	ok+	ok	ok+	ok	ok
15.03 Piezoelectrics											

Legenda: ok+ ok ok-

Piezoelectric Materials

Corso Materiali intelligenti e Biomimetici
15/03/2019

ludovica.cacopardo@ing.unipi.it

Piezoelectricity

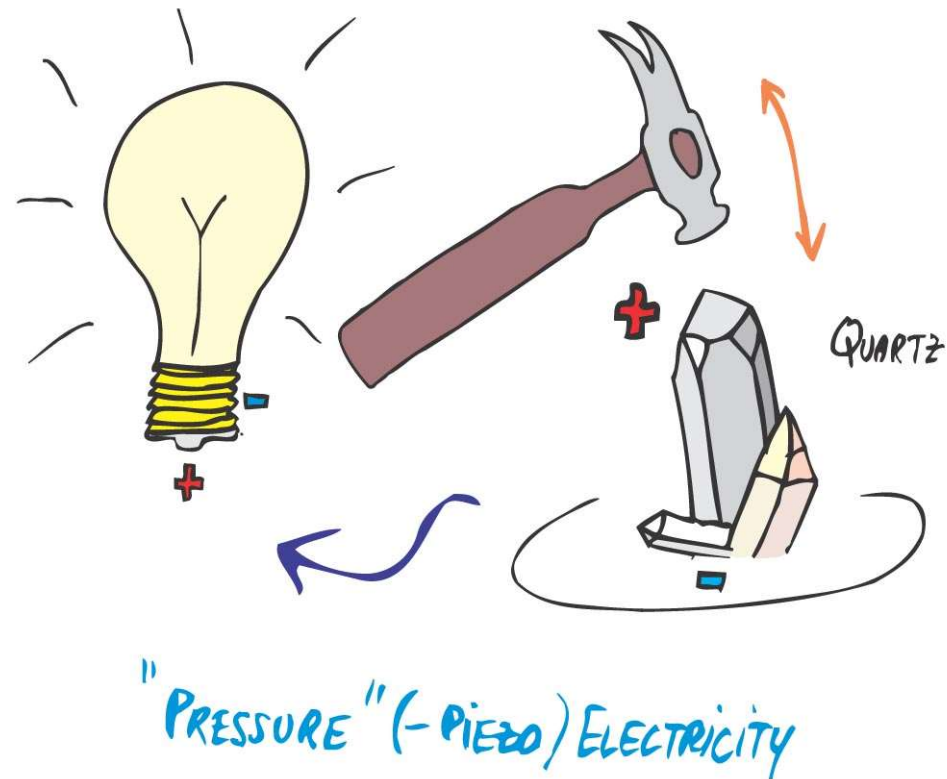

The word piezoelectricity is derived from the ancient Greek words *piezo*, "to squeeze or press," and *electric*. So, piezoelectricity literally means electricity from pressure.

Example

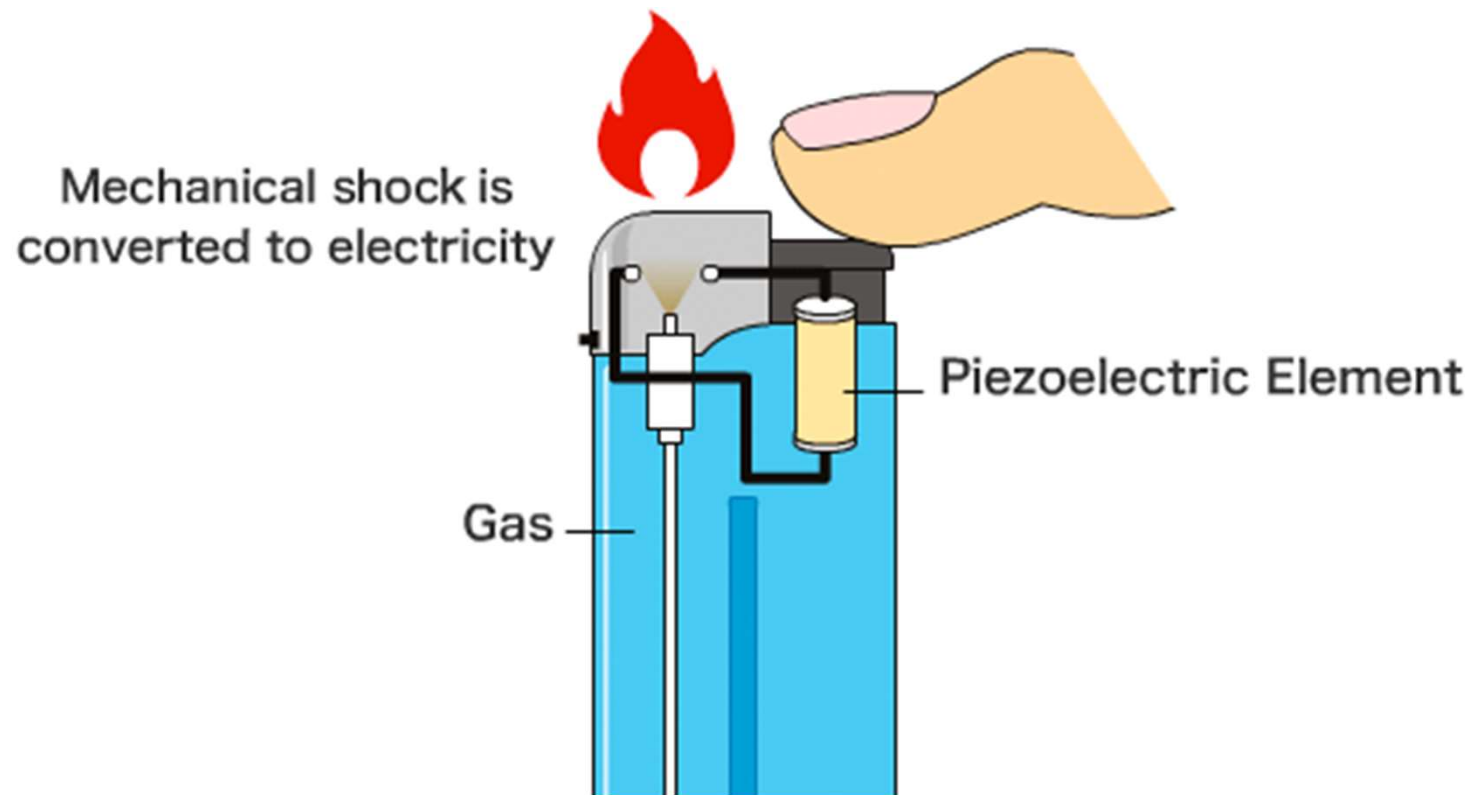

The piezoelectric effect

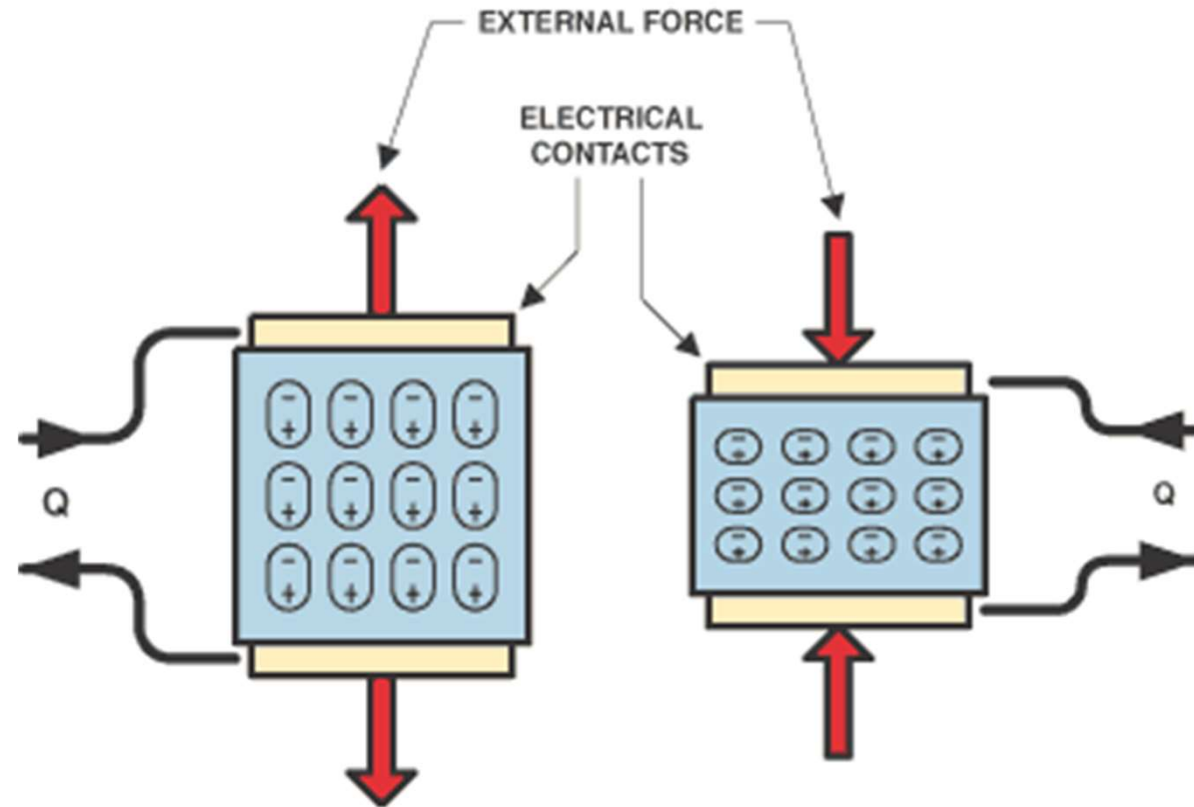

In piezoelectric materials, **when a mechanical stress (pressure) or strain (deformation) is applied to the material, the response is the generation of an internal charge.** This charge can be described as electrical potential energy (voltage) that can be used like any other energy source.

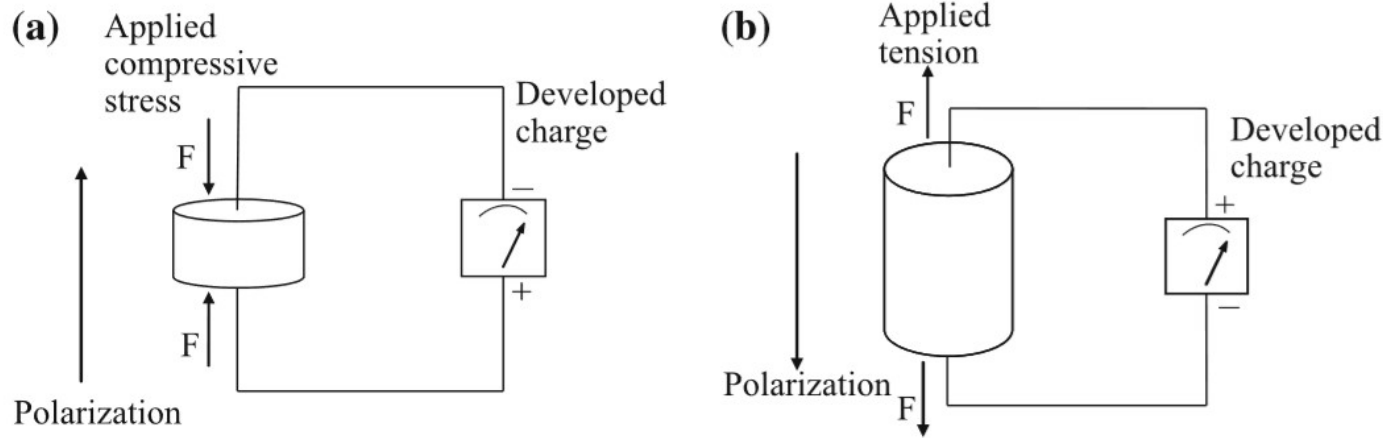

Fig. 2.1 Direct piezo-effect: **a** at applied compressive stress, **b** at applied tension

The conversion of mechanical forces into electrical potential is called the **direct piezoelectric effect**.

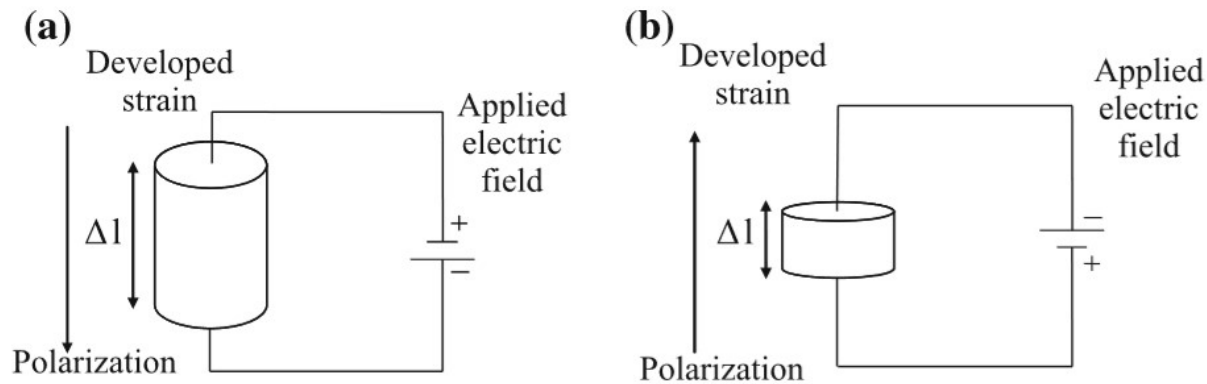

Fig. 2.2 Inverse piezo-effect at applied electric field

On the other hand, if a piezoelectric material is subjected to an external electric field, the response is mechanical deformation of the material—called the **inverse piezoelectric effect**.

Constitutive equations

Electric induction
Direct Piezoelectric effect

$$D_i = \varepsilon_{ij} E_j + d_{ijk} \sigma_{jk}$$

Permittivity Electrical field Direct piezoelectric effect matrix Mechanical stress

The diagram shows the equation $D_i = \varepsilon_{ij} E_j + d_{ijk} \sigma_{jk}$. Four blue arrows point from the terms to their physical meanings: from ε_{ij} to 'Permittivity', from E_j to 'Electrical field', from d_{ijk} to 'Direct piezoelectric effect matrix', and from σ_{jk} to 'Mechanical stress'.

Mechanical strain
Inverse Piezoelectric effect

$$e_{ij} = d_{kij} E_k + C_{ijkl} \sigma_{kl}$$

Inverse piezoelectric effect matrix Electrical field Mechanical compliance Mechanical stress

The diagram shows the equation $e_{ij} = d_{kij} E_k + C_{ijkl} \sigma_{kl}$. Four blue arrows point from the terms to their physical meanings: from d_{kij} to 'Inverse piezoelectric effect matrix', from E_k to 'Electrical field', from C_{ijkl} to 'Mechanical compliance', and from σ_{kl} to 'Mechanical stress'.

The peculiarity of piezoelectricity is the **third order coupling tensor** d_{kij} that **couple mechanical and electrical quantities**. Assuming polarization on always on direction 3, these coefficients refer to three main coupling mechanisms:

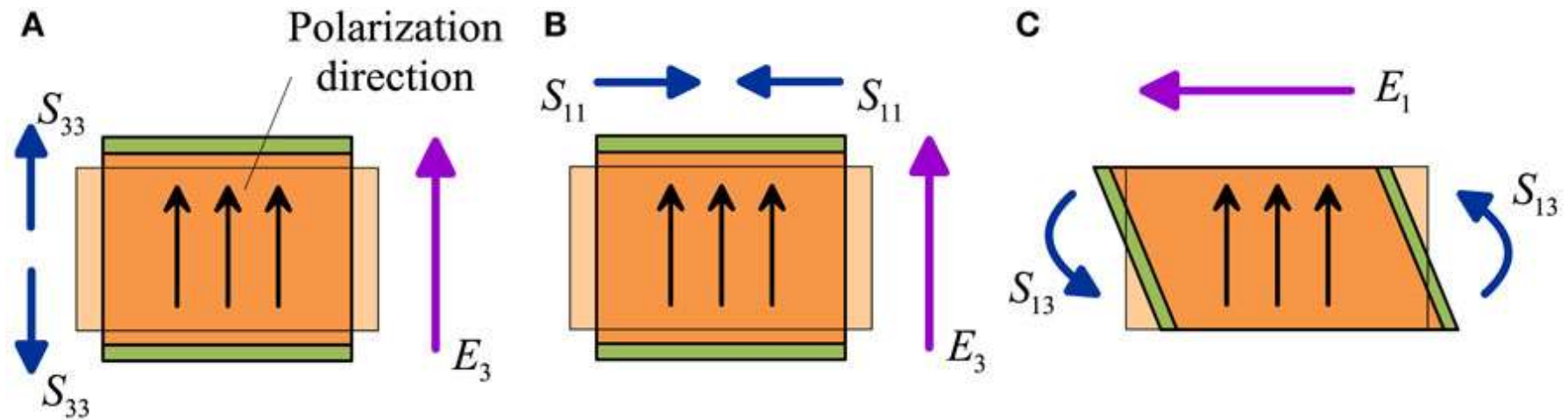

$$S_{ij} = \text{strain} = e_{ij}$$

- (a) **33-mode**: when applying an **electric field along the polarization axis**, the piezoelectric element **stretches in this same direction** (and vice versa);
- (b) **31-mode**: when applying an **electric field along the polarization axis**, the piezoelectric element **shrinks in the orthogonal plane** (and vice versa);
- (c) **Shear mode**: when applying an **electric field orthogonal to the polarization axis**, a **shear** occurs in the element plane (and vice versa).

Material electric properties

Conductors

Electric charges flows within the material under an external electric field

Dielectrics

Electric charges do not flow (no free electrical charge), they are only slightly displaced from their equilibrium positions

Dipole: volume unit with a neutral global charge, but where $q+$ and $q-$ are dislocated

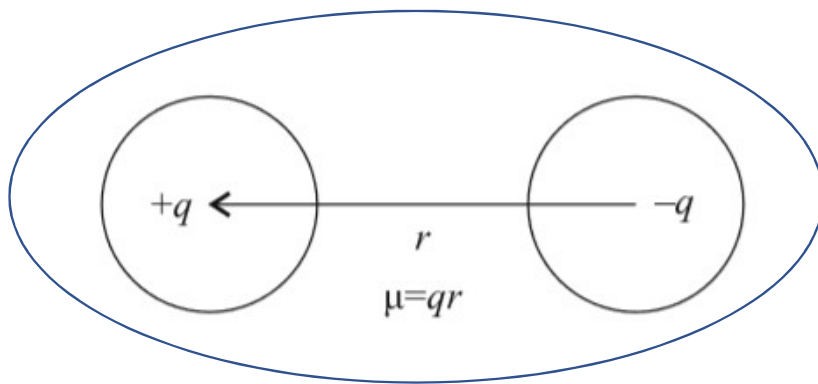

μ = dipole moment, r =distance between the charges,
 q =charge

When an external electrical field is applied the electric dipoles align with it. The **polarization of a material** is simply the total dipole moment for a unit volume:

$$P = \frac{1}{V} \sum_i \mu_i$$

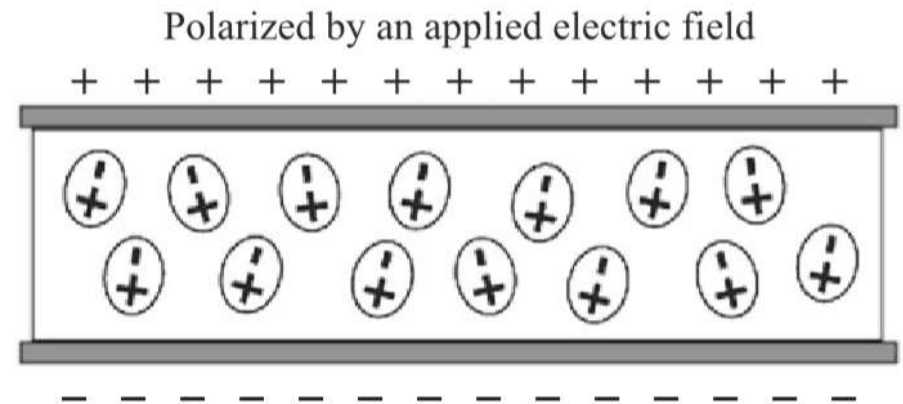

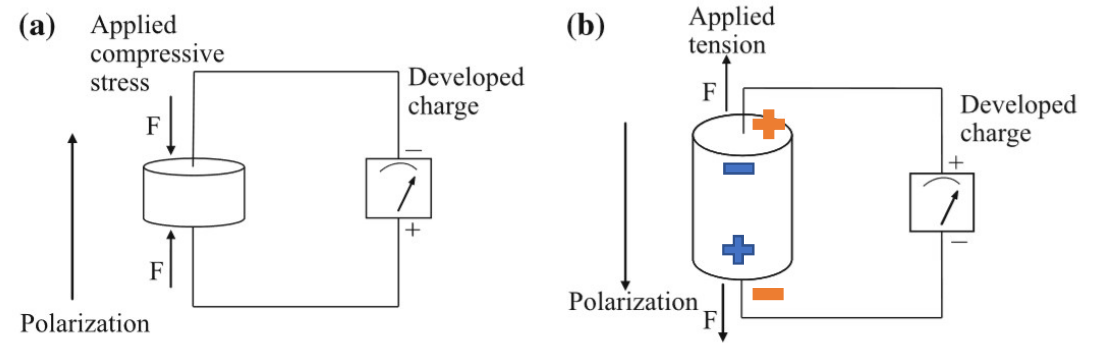
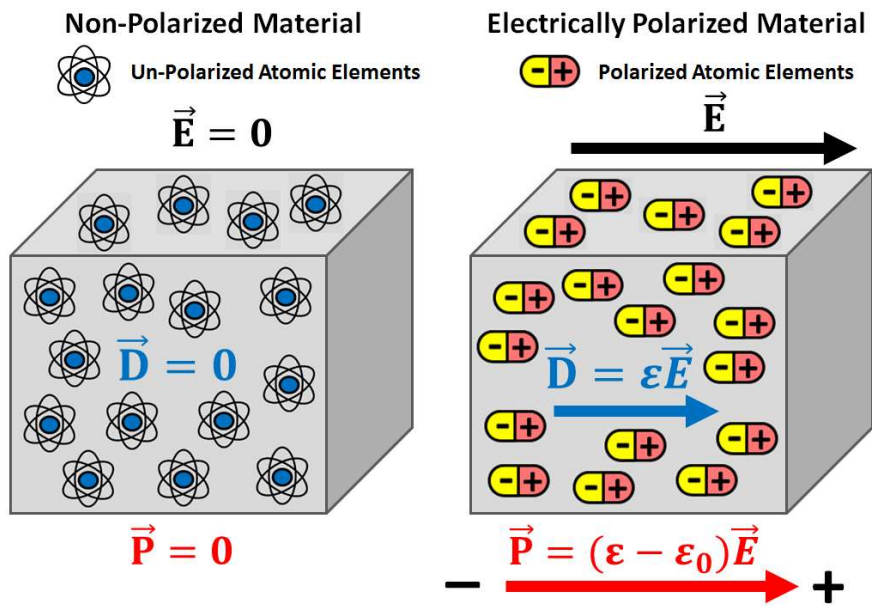

Fig. 2.1 Direct piezo-effect: **a** at applied compressive stress, **b** at applied tension

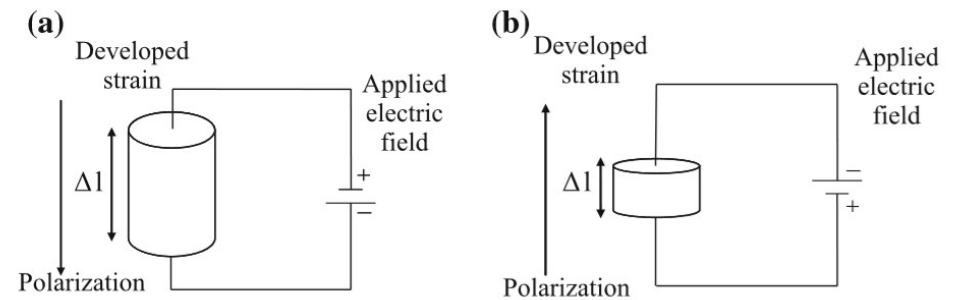
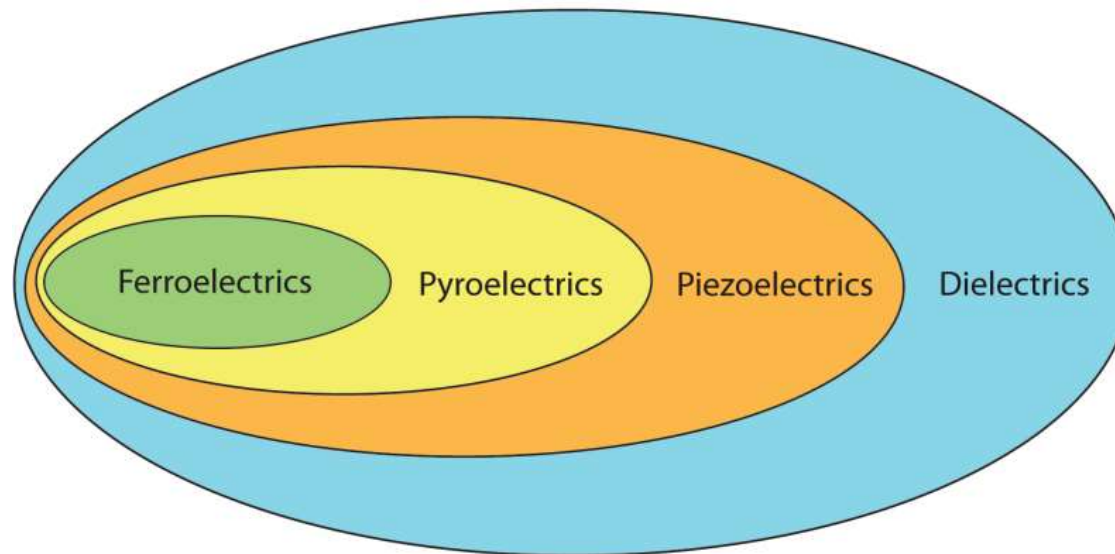

Fig. 2.2 Inverse piezo-effect at applied electric field

Piezoelectric Materials

When a **dielectric is placed in an electric field, it becomes polarized** – positive and negative charges are separated, producing a dipole with dipole moment given by the product of the charges and their separation distance. **Simultaneously, the dielectric experiences an electrostrictive strain**, which is quadratic to the polarization. However, the electrostriction is usually negligibly small and bears no practical significance.

However, **if the dielectric has an asymmetric atomic structure, a relatively large piezoelectric strain proportional to the electric field is also possible**. Vice versa, when a piezoelectric material is loaded electrically then the **electrical dipoles** appear.



Atomic structure in not piezoelectric materials

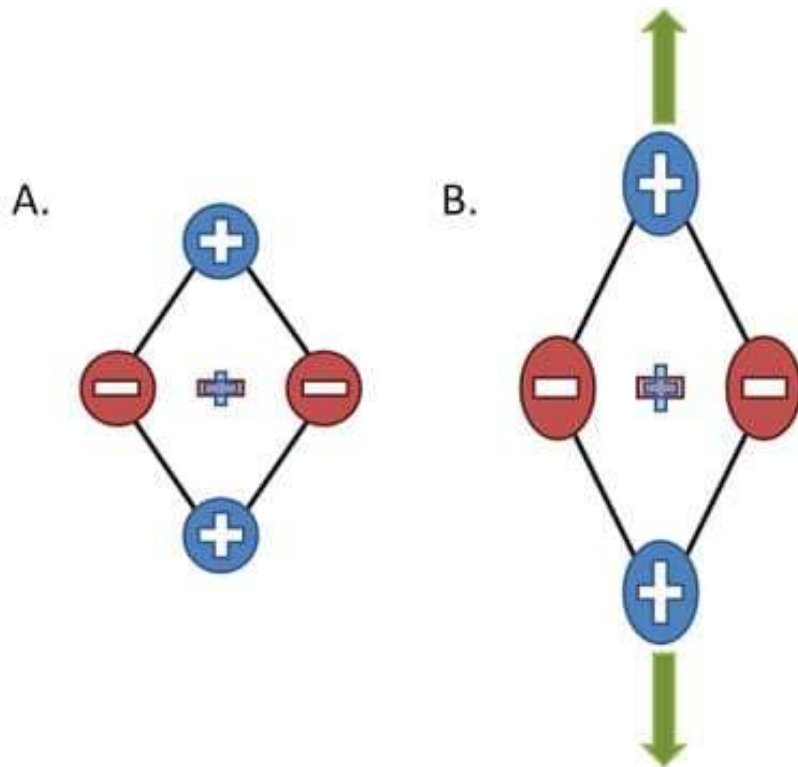

Example: *crystal containing four total atoms, two positively charged and two negatively charged, arranged in a diamond pattern.* When we look at the average location of the negative charges and the average location of the positive charges, we notice that they are the same. Thus, **no electric potential exists.**

Similarly, **when the crystal is mechanically deformed no change results in the average locations of the charges.** This material shows **no electrical response** to a mechanical force and thus is not piezoelectric. The symmetry can be demonstrated by drawing an arrow to any of the four atoms with a starting point in the center of the crystal, and then drawing the same arrow in the opposite direction. If they point to the same type of atom, it is symmetrical.

Atomic structure in piezoelectric materials

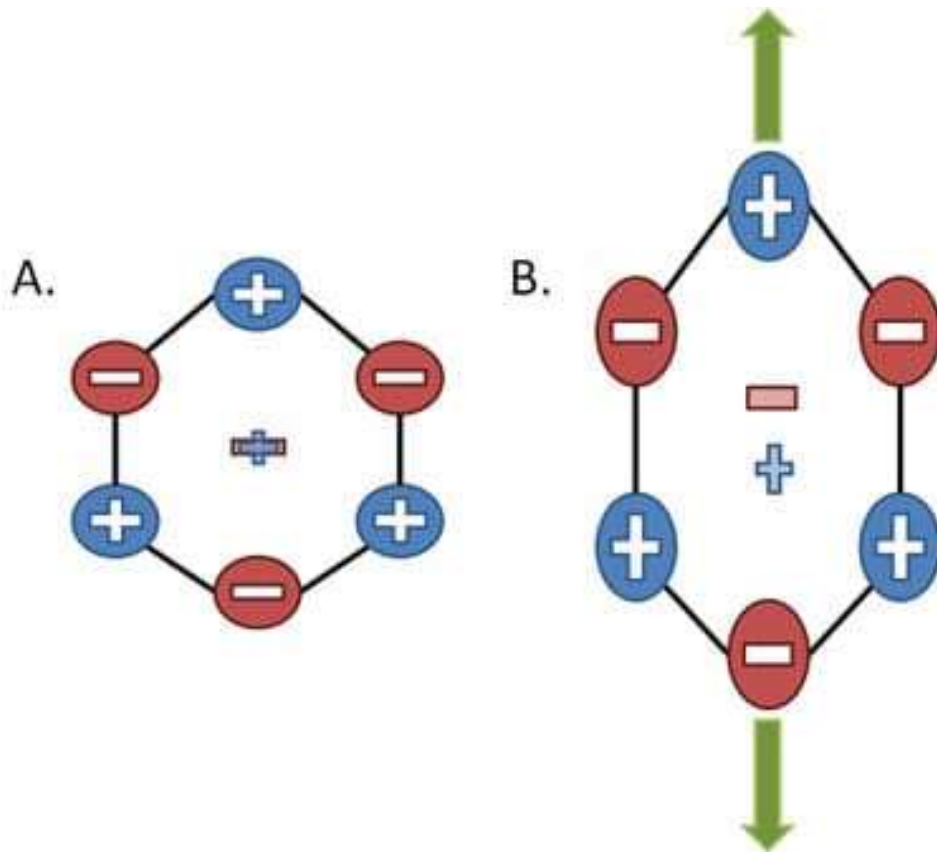

The atomic structure of piezoelectric materials is not completely symmetric.

If we calculate the average location of the positive and negative charges, we find that they are the same.

However, **when the material is deformed the average positions of the charges are different.** Performing the same arrow-drawing exercise as before, we find that while this material may look symmetric, drawing the opposite arrow does not point to the same type of atom. Thus, **this material has an electrical response to a mechanical force** (and vice versa) and is piezoelectric.

Pyroelectric and Ferroelectric Materials

About 20 crystalline classes without a symmetry center are piezoelectric.

10 of them possess a **unique axis that is spontaneously polarized**. These 10 polar classes are referred to as pyroelectric, whose **spontaneous polarization varies with temperature**.

If such spontaneous polarization can be reversed by an external electric field, then the pyroelectric is also ferroelectric, i.e. ferroelectricity refers to the switchability of spontaneous polarization, which usually results in a hysteresis loop between polarization and the electric field.

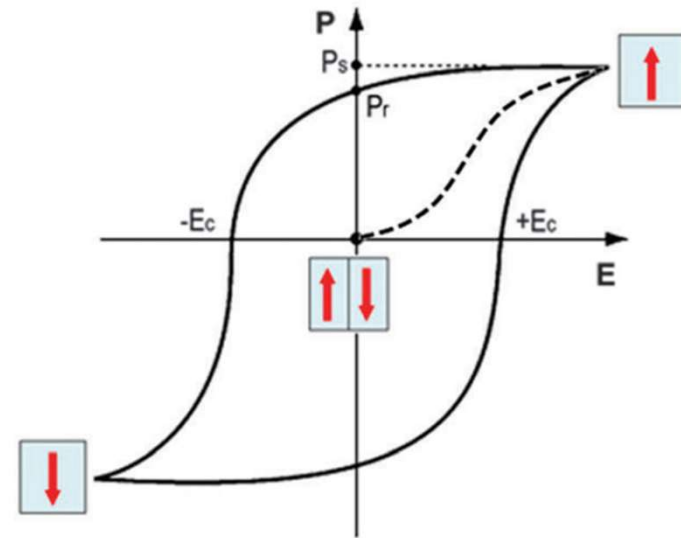
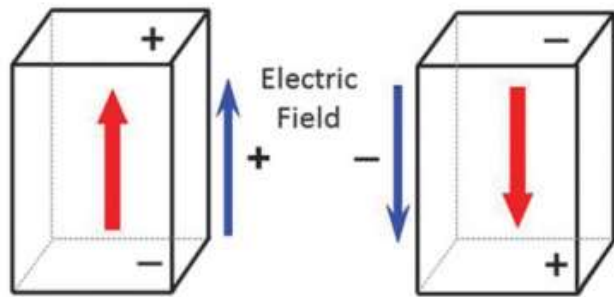

Curie Temperature: T at which the material present a spontaneous polarization (indeed the spontaneous polarization decreases with increased temperature)

Ferroelectric Materials

Butterfly Loop

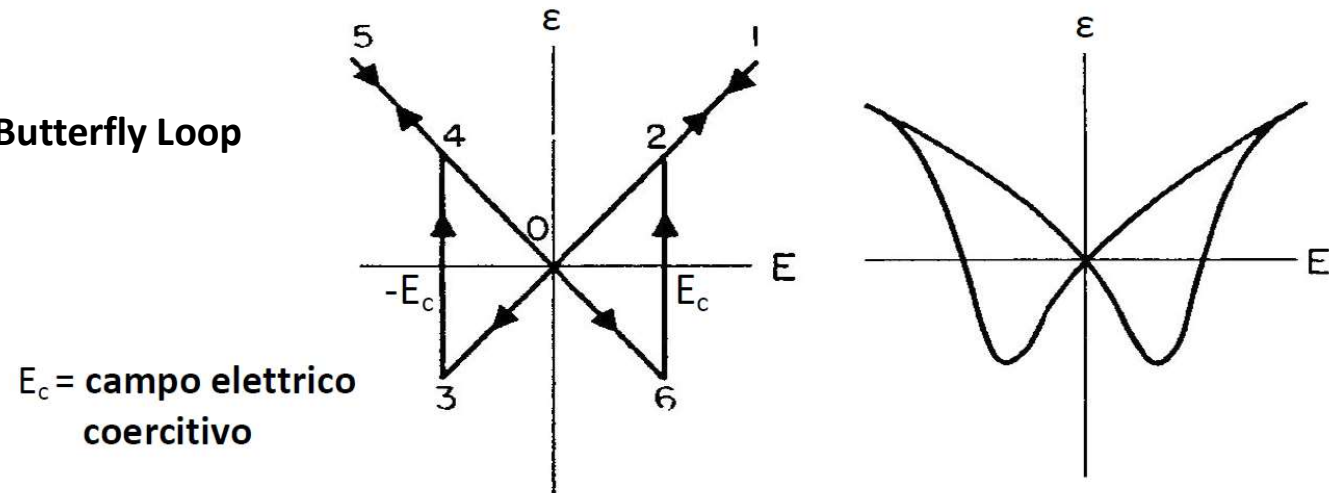

E_c = campo elettrico
coercitivo

- 0-1-2 Applicando un campo elettrico E nella direzione di polarizzazione il materiale si allunga ($\epsilon > 0$)
- 0-3-4 Se si inverte il campo elettrico il materiale dapprima si contrae ($\epsilon < 0$), finché non raggiunge un'intensità $-E_c$ sufficiente a far invertire la direzione di polarizzazione del materiale
- 4-5 Per $E < -E_c$ l'atomo centrale si sposta dalla parte opposta, variando il verso del dipolo, e il materiale riprende ad allungarsi

In realtà, i materiali piezoelettrici evidenziano comportamenti non lineari e isteresi

**E coercitivo = intensità del campo elettrico inverso necessario ad annullare la sua elettrizzazione dopo che questa ha raggiunto il suo valore di saturazione*

Ferroelectric Materials

If a **mechanical stress** is applied to pyro/ferroelectrics (in absence of external E), then there are domains which will experience an **increase in dipole moment** and some which will experience a **decrease in dipole moment**. Overall, there is **no net increase in polarization**.

This makes the material useless as a piezoelectric unless it is put through some additional processing.

Poling: an electric field is applied to the ferroelectric below its *Curie temperature*, so that its spontaneous polarization develops and it is aligned in a single direction. When the electric field is removed most of the dipoles are locked in a configuration of near alignment.

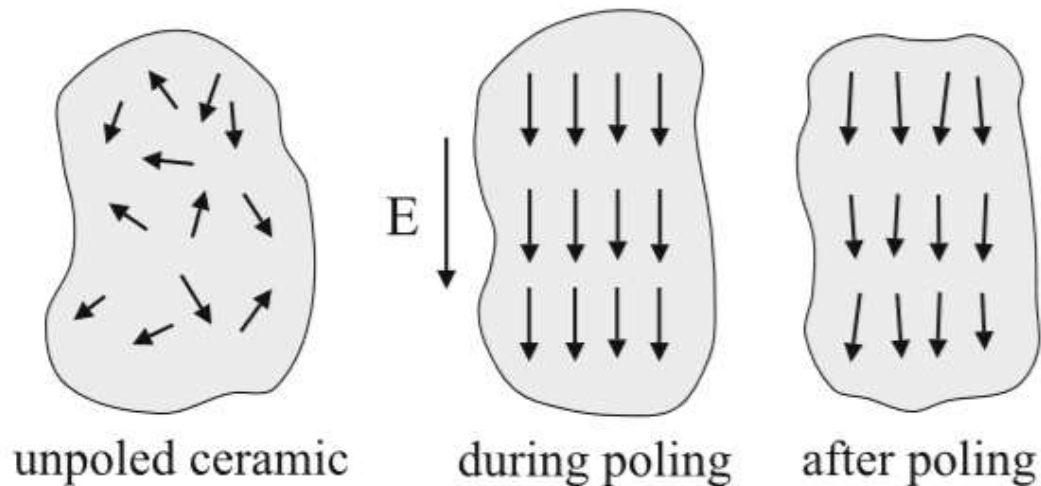

In summary

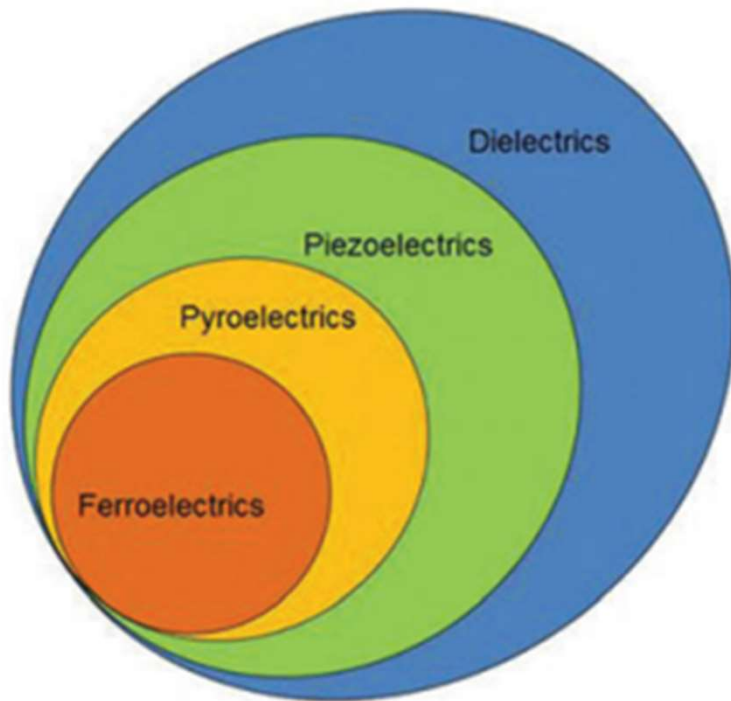

- **Dielectric materials** -> polarized under an external electric field
- **Piezoelectric materials** are 'special' dielectric materials -> polarization *occurs* after the application of a mechanical stress due to the asymmetric atomic structure
- Some of them (**pyroelectric and ferroelectric**) presents a spontaneous polarization ($T < T_{\text{curie}}$) -> the polarization *increases or decreases* after the application of a mechanical stress

Natural Piezoelectric Materials



Quartz crystal cluster from Tibet



Topaz



Sugar Cane



Tendon



DNA



Rochelle Salt



Schorl Tourmaline



Dentine/ Enamel



Bone

Example (Natural): atomic structure of Quartz

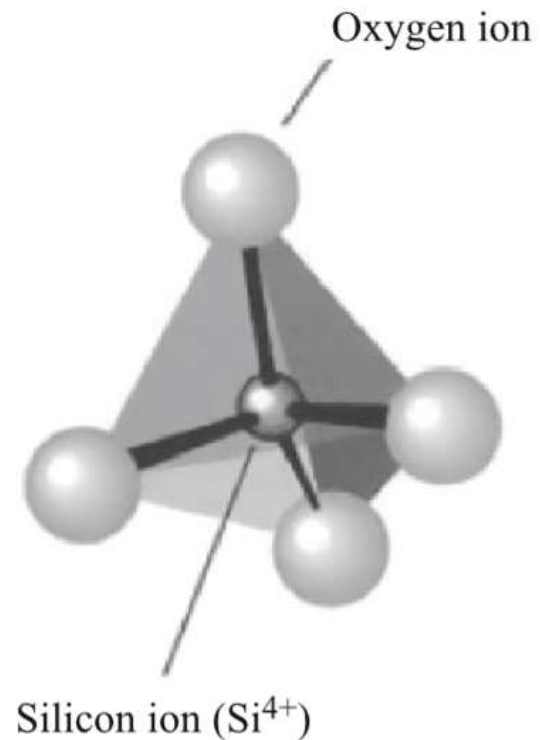

The lattice structure is a *tetrahedron* built of *four oxygen atoms around a silicon atom*.

Each oxygen atom has the same distance to the silicon atom, and the distances between the oxygen atoms are all the same.

The **change in the position of the atoms due to applied stress** leads to the formation of net dipole moments that causes polarization and an electric field, respectively.

Synthetic piezoelectric materials

- **Ceramics:**

The general chemical formulae of perovskite crystal structure is XYO_3

where X is a larger metal ions (e.g. Pb or Ba), Y is a smaller metal ion (e.g. Ti or Zr) .

Examples: Barium titanate (BaTiO₃); Lead titanate (PbTiO₃); Lead zirconate titanate (PZT)

- **Polymers:**

polyvinylidene fluoride (PVDF) is a ferroelectric polymer.

- **Composites:**

- *piezo-polymer* in which the piezoelectric material is immersed in an electrically passive matrix (e.g. PZT in epoxy matrix)

- *two different ceramics* (for example BaTiO₃ fibers reinforcing a PZT matrix).

Example (Synthetic): Atomic structure of BaTiO₃

Above the Curie T , each crystal exhibits a *simple cubic symmetry with no dipole moment*.

At temperatures **below the Curie point**, each crystal exhibits a *tetragonal symmetry leading to a dipole moment*; this phase of the material is called ferroelectric phase.

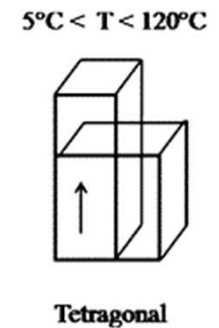
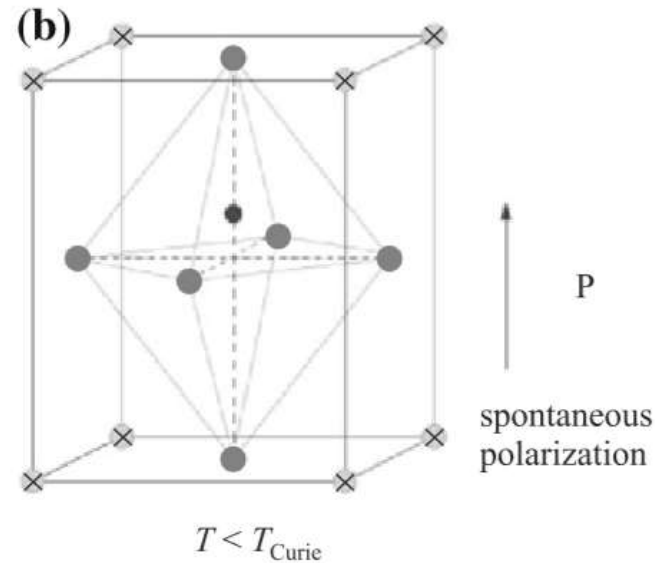
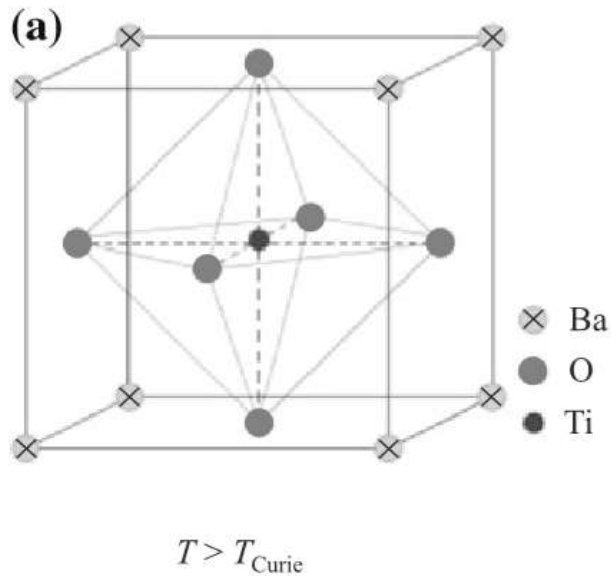
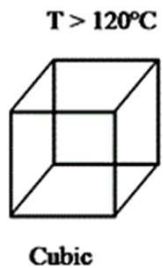

1 Ceramic binder and powder are compounded together to form an injection molded feedstock

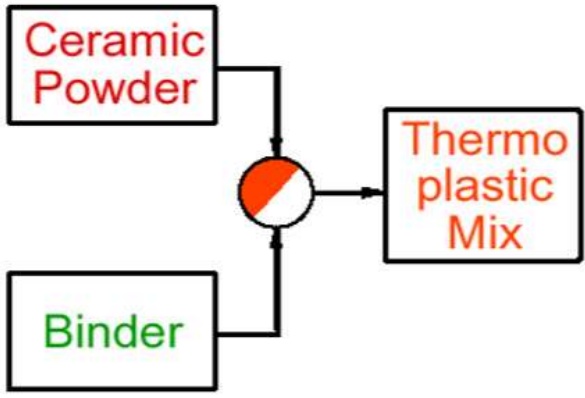

2 The heated feedstock is injection molded into a cold mold

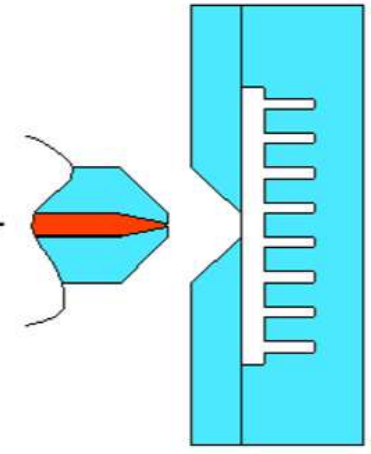

3 The liquid feedstock quickly fills the mold and freezes

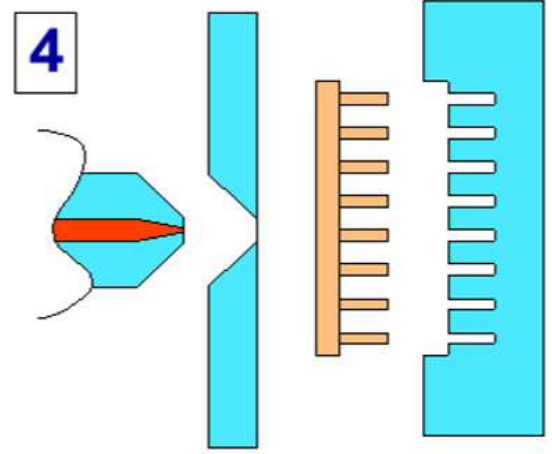
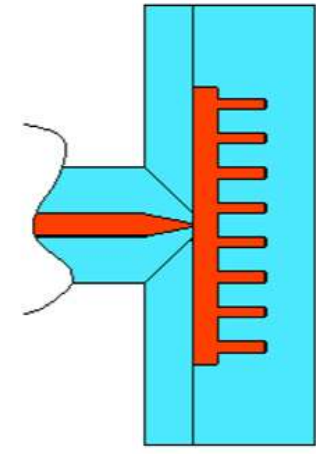

Solid parts are ejected

5 Parts are burned out to remove the binder

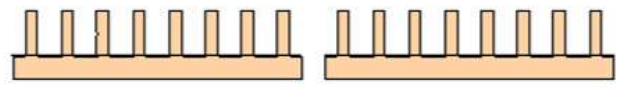

6 A high temperature sintering process is used to densify the ceramic

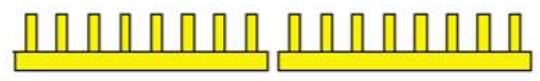

7 Parts are poled under high electric field

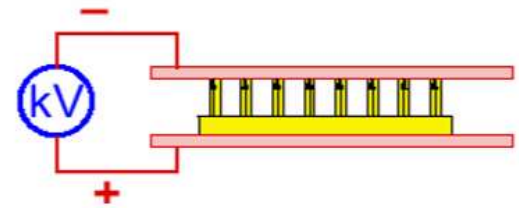

Sensors

- PIROELECTRICITY:

A change in temperature of the sample leads to a change in net dipole moment and spontaneous polarization, which results in a **change in the quantity of surface charges**. The free charges flow to compensate for the change, which leads to the **pyroelectric current flow in the circuit**

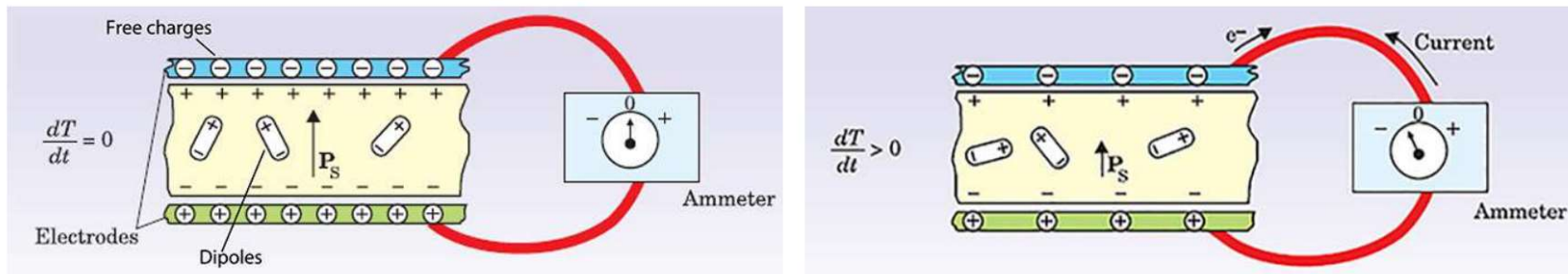

(a) An electroded pyroelectric material at constant temperature.

(b) Current flow upon an increase in temperature.

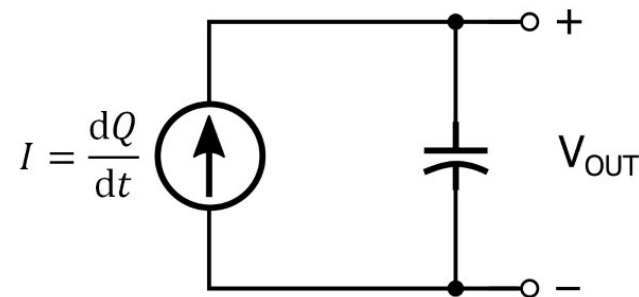

Sensors

- DIRECT PIEZOELECTRIC EFFECT: displacement sensor

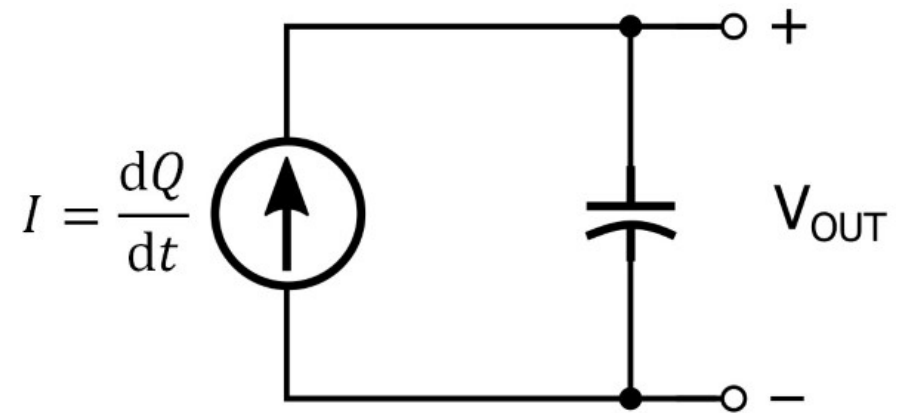
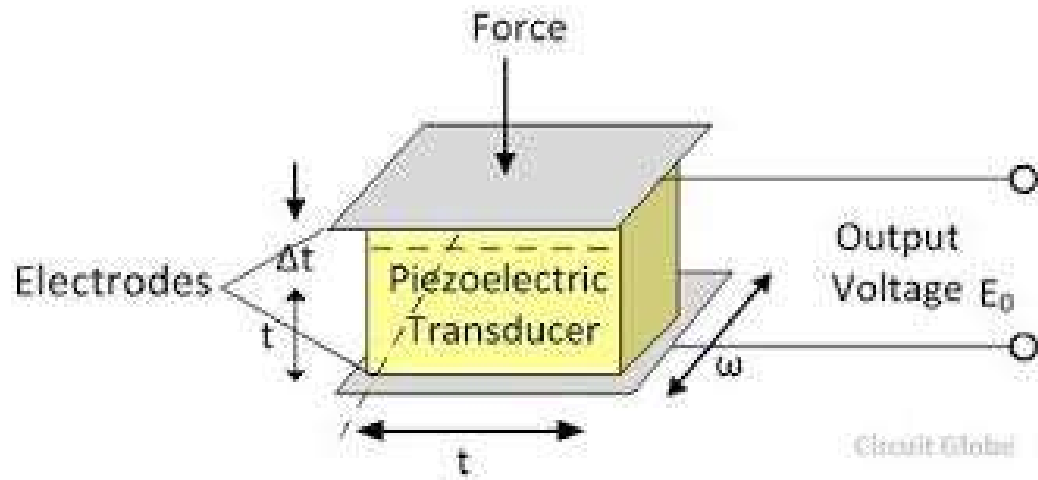

Piezoelectric actuator and motors

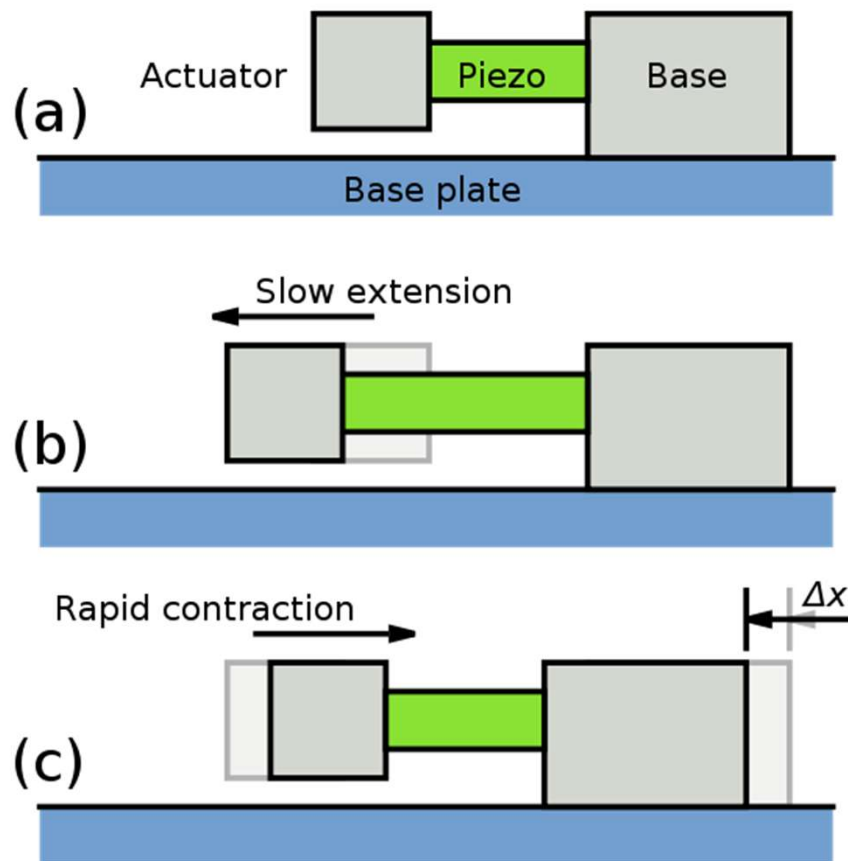

Gli attuatori e i motori piezoelettrici sfruttano l'**effetto piezoelettrico inverso** convertendo energia elettrica (tensione e corrente) in energia meccanica (forze e spostamenti).

Gli **attuatori** propriamente detti sono dei dispositivi che si presentano *monolitici* (Solid-State Actuators) mentre i **motori** sono costituiti da *più parti*.

Multilayer actuators

Un attuatore piezoelettrico multilayer è costituito da una serie di **lamine piezoelettriche impilate** una sopra l'altra e racchiuse tra due elettrodi.

Per un'ottimizzazione delle dimensioni e del numero di componenti, tra due lamine adiacenti vi è un solo elettrodo: i **campi elettrici** generati dalla differenza di potenziale applicata agli elettrodi, perpendicolari alle lamine, **cambiano quindi verso ad ogni strato**.

Perchè le deformazioni indotte si sommino in maniera costruttiva le lamine piezoelettriche adiacenti devono avere **polarizzazione di verso alterno**.

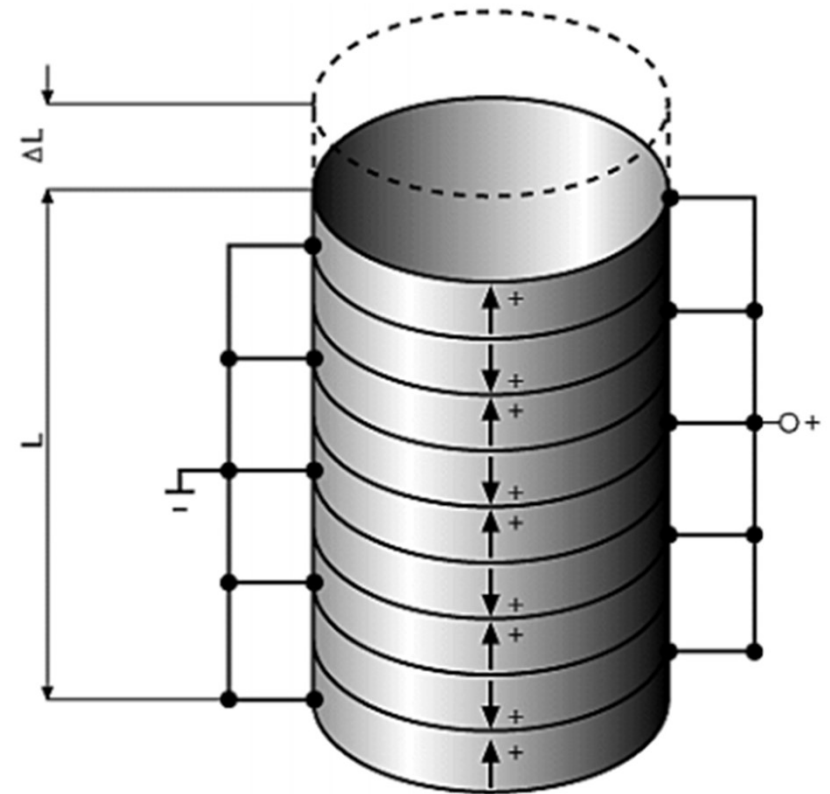

Amplificazione movimento

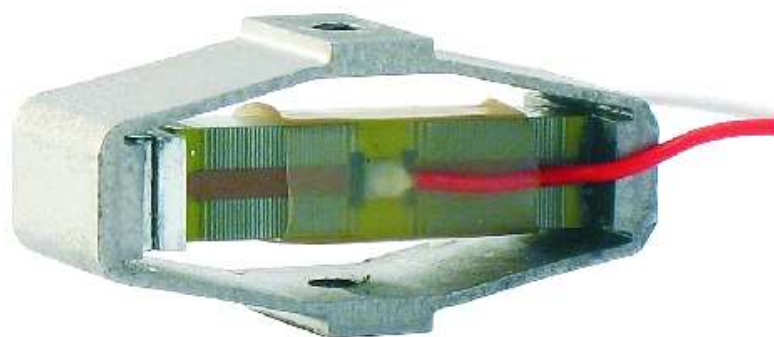

(7.a)

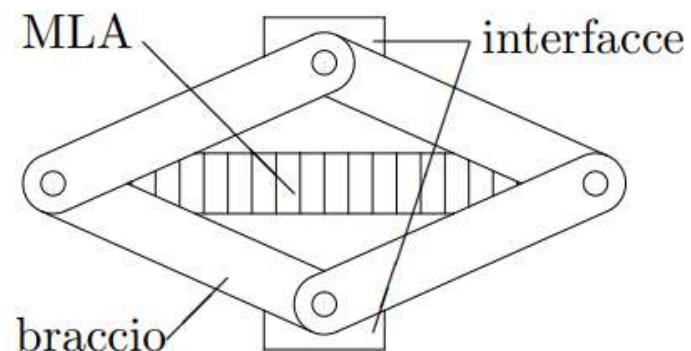

(7.b)

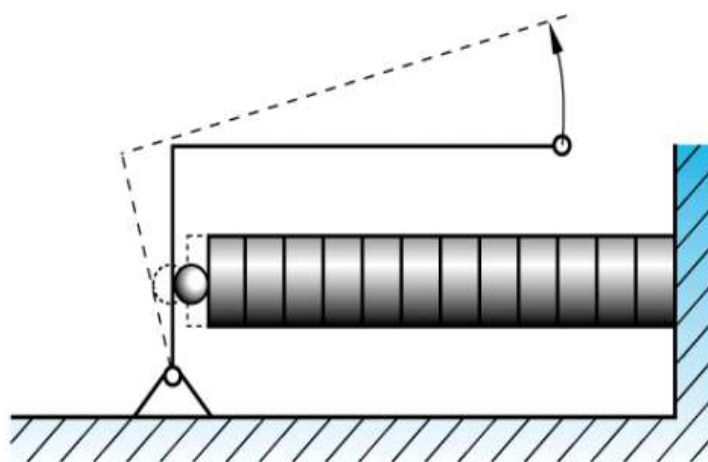

Bending Actuator

Attuatori in grado di generare una *flessione dovuta alla contrazione di uno strato e all'espansione dell'altro adiacente*.

L'attuatore **unimorfo** è costituito da una lamina piezoelettrica e da uno strato passivo di materiale genericamente metallico che funge anche da elettrodo.

L'attuatore **bimorfo** invece presenta uno strato centrale di materiale passivo sulle cui superfici superiore e inferiore vengono incollati due strati di materiale piezoelettrico. Gli elettrodi sono applicati sulle superfici superiore e inferiore di ciascuno strato piezoelettrico.

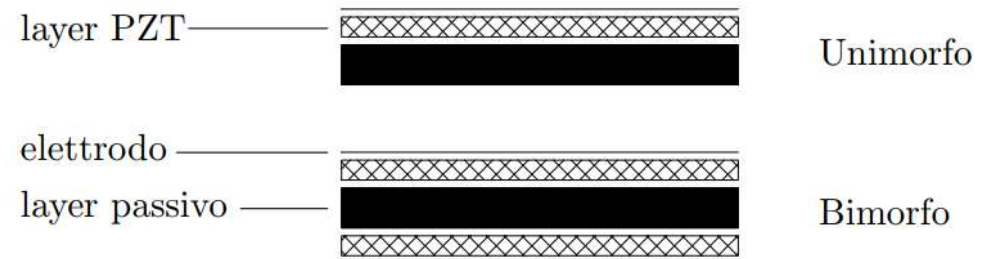
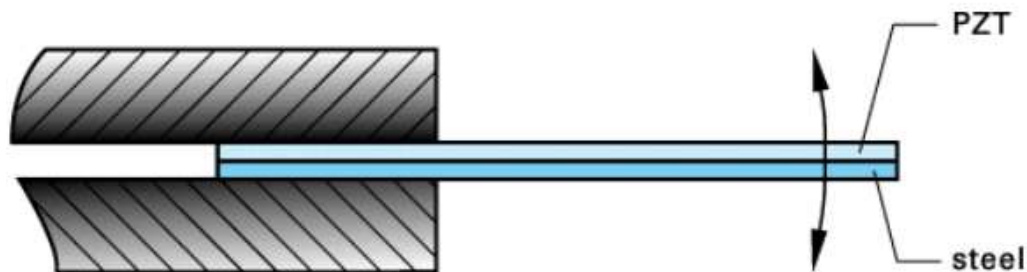

Piezoelectric 'inch-worm' motors



Figura 11: Motore inchworm e segnali di pilotaggio

Il motore è costituito da una **parte fissa esterna** e da una parte mobile formata da **tre attuatori piezoelettrici** (parti 1, 2 e 3).

L'attuatore **1** è responsabile della **traslazione** mentre gli attuatori **2 e 3 vincolano la parte mobile a quella fissa**.

Un'opportuna sequenza di segnali di pilotaggio consente una traslazione lungo la parte fissa.

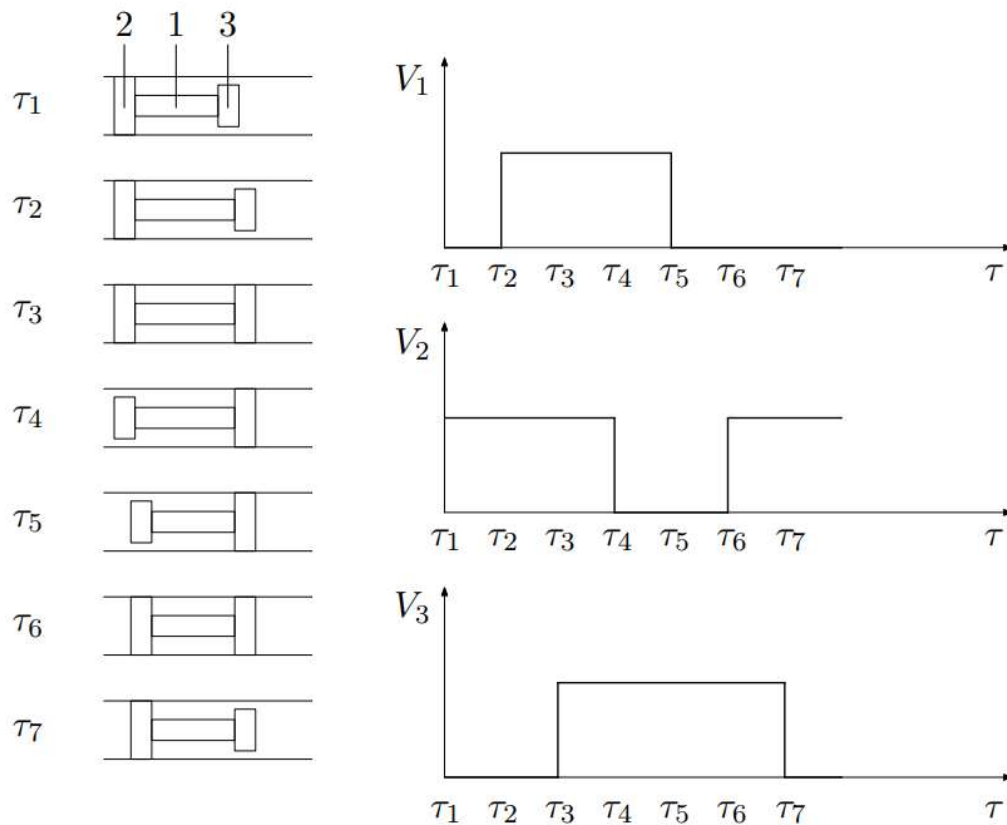
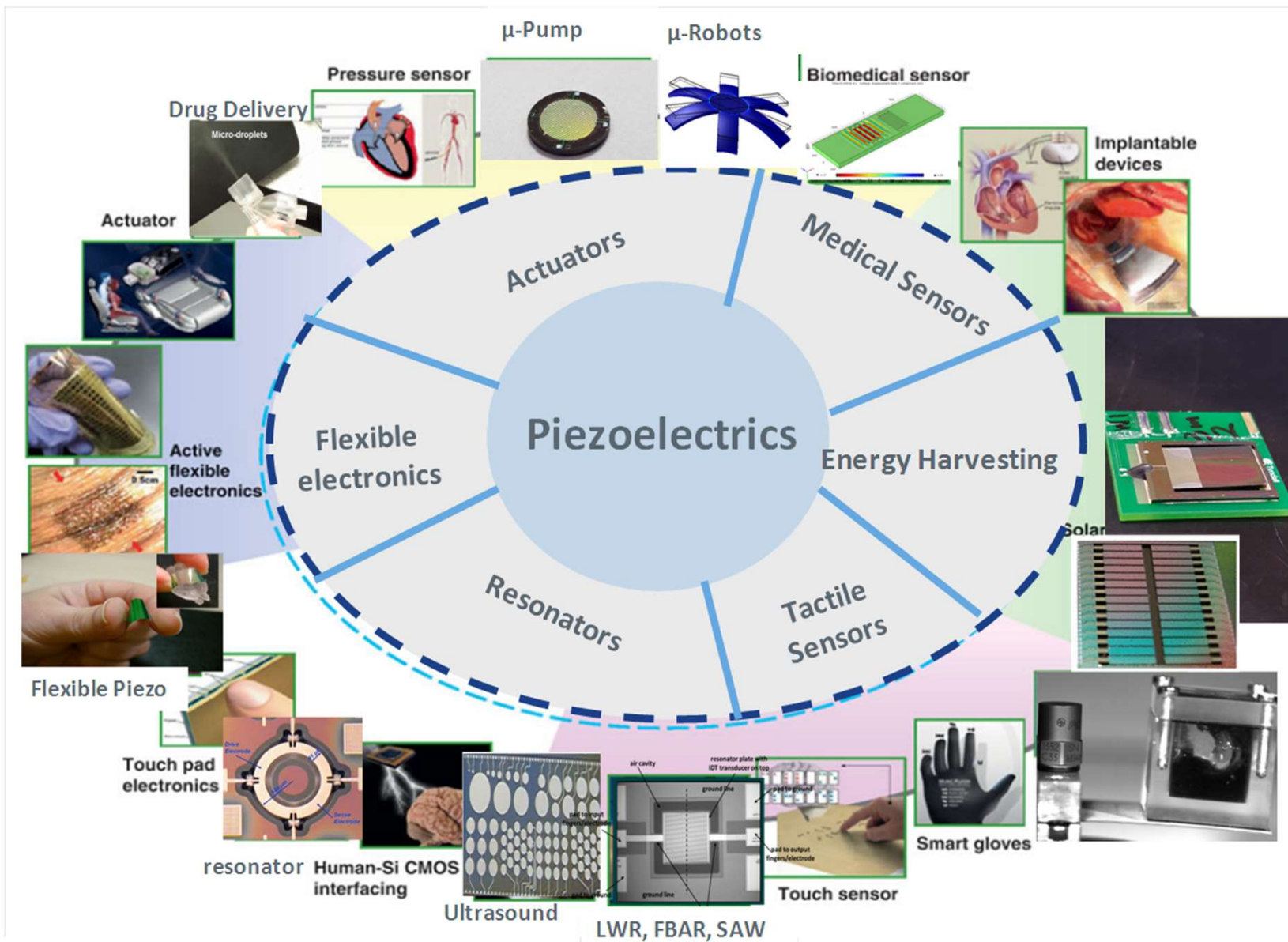

Attività di gruppo

- Trovare un articolo con un'applicazione interessante di un materiale piezoelettrico (non necessariamente biomedica) e realizzare una slides riassuntiva che evidenzi come le proprietà del materiale sono state sfruttate ai fini dell'applicazione