

# Sviluppo, regolazione e morfogenesi

- 1) Lo sviluppo evolutivo di una struttura o parte di un organismo
- 2) Lo sviluppo embrionico di una struttura o parte di un organismo
- 3) Il processo che avviene in un complesso sistema-ambiente che elabora la sua forma o struttura. Esempi: crescita, apprendimento e sviluppo di una società.

Un sistema morfogenetico è capace di mantenere la sua continuità e integrità cambiando aspetti essenziali della sua struttura o organizzazione.

**Regolazione (regulation).** Uno delle proprietà più importanti e elusive dei organismi viventi è la capacità di regolare forma e grandezza. (ad esempio la testa cresce di meno, le orecchie raggiungono la loro grandezza finale a 5-6 anni).

Alcuni aspetti cellulari della morfogenesi sono stati elucidati, e aspetti molecolari sono l'argomento di studio. Quello che manca è una visione globale, che unisce il molecolare con il macro molecolare. Abbiamo le risposte a "come?", ma non a "perché?"

Development: understanding what happens will lead to new methods of regeneration, and give clues on how to engineer new tissues in the lab.

- Growth : increase of mass
- Morphogenesis: they move and rearrange
- Differentiation: emergent parts become different

FORM and FUNCTION

## Differenze tra la morfogenesi e l'ingegneria tissutale

<b>Morfogenesi</b>	<b>Ingegneria Tessutale</b>
Utilizzo di cellule staminali	Cellule adulte o staminali
Le cellule producono il materiale extra-cellulare	Di solito viene introdotto uno scaffold
Il tessuto e l'ambiente vengono modulati in tempo reale dalla struttura stessa	L'architettura di una scaffold è pre-programmata
Crescita per aumento di massa da un punto sorgente	Crescita per demolizione progressiva dello scaffold e contemporanea produzione di EMC dalle cellule
La morfogenesi è dovuta a segnali interni alle cellule	La forma viene dettata dalla geometria dello scaffold

Fertilization begins when a sperm penetrates an oocyte (an egg) and it ends with the creation of the **zygote**.

The early process of cell division is **Cleavage**  
The First Cell Divisions produce **Blastomeres**, undifferentiated cells, each one is totipotent

After about sixteen cells (and how many divisions?), the zygote becomes a **morula** (mulberry shaped) .

At this stage it is called a blastocyst. This is the first stage of morphogenesis.

The presence of the blastocyst indicates that two cell types are forming: the **embryoblast** (inner cell mass on the inside of the blastocele (inner cavity), and the **trophoblast** (the cells on the outside of the blastocele)

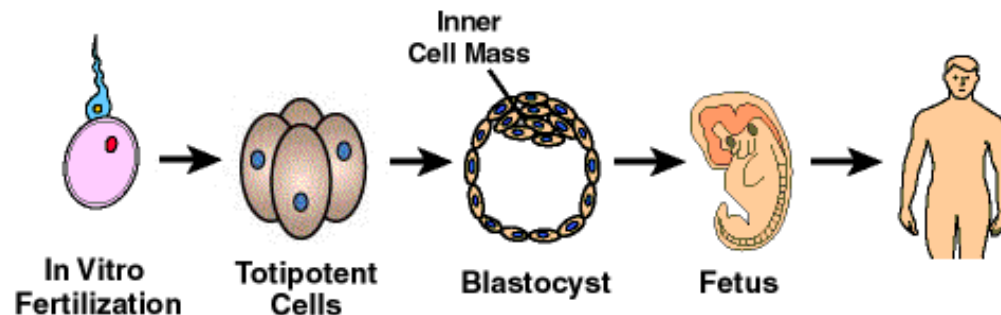

Zygote: not symmetrical (why?) - POLARITY.  
Almost all have an ANIMAL pole (nr nucleus) and a  
VEGETAL pole (far from nucleus)

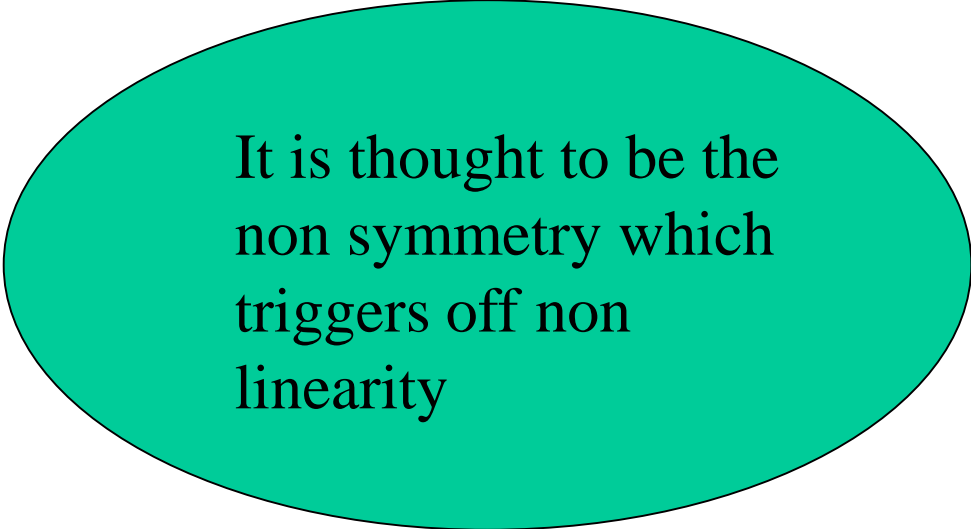

It is thought to be the  
non symmetry which  
triggers off non  
linearity

The trophoblast forms the placenta

The inner cell mass or embryoblast: the fetus

The blastocyst is pluripotent, or what we call **embryonic stem cells**. (see stem cells)

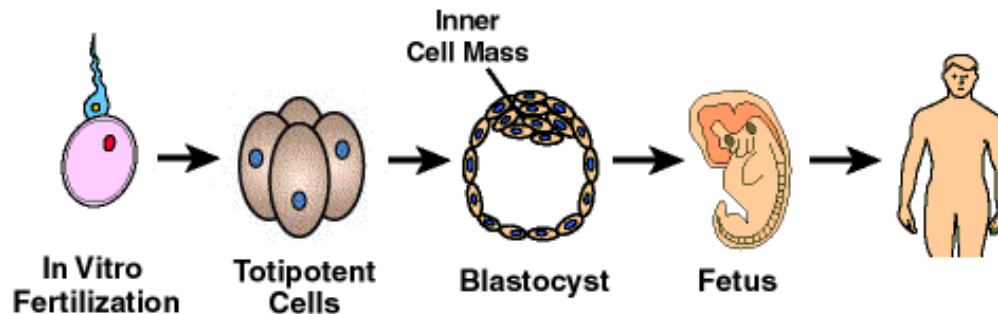

What's happening? The fertile egg is symmetrical. Each step leads to a greater level of **asymmetry**.

This is what we call morphogenesis.

The development of form and function.

The next step is called Gastrulation : a crucial time in the development of multicellular animals.

*"It is not birth, marriage, or death, but **gastrulation**, which is truly the most important time in your life."*

Lewis Wolpert (1986)

During gastrulation, **the 3 germ layers of an embryo are formed** and the body plan of the mature organism is established. Movements on a massive scale allow cells to establish great complexity from a very simple starting form .

1. The three primary germ layers (ectoderm, mesoderm & endoderm) are established.
2. The basic body plan is established, including the physical construction of the rudimentary primary body axes.
3. As a result of the movements of gastrulation, cells are brought into new positions, allowing them to interact with cells that were initially not near them.

**Endoderm:** the most internal germ layer, forms the lining of the gut and other internal organs.

**Ectoderm,** the most exterior germ layer, forms skin, brain, the nervous system, and other external tissues.

**Mesoderm,** the the middle germ layer, forms muscle, the skeletal system, and the circulatory system.

There are two major types of cell arrangements in the embryo: **epithelial cells**, which are tightly connected to one another in sheets or tubes, and **mesenchymal cells**, which are unconnected to one another and which operate as independent units. **Morphogenesis is brought about through a limited repertoire of variations in cellular processes within these two types of arrangements: (1) the direction and number of cell divisions; (2) cell shape changes; (3) cell movement; (4) cell growth; (5) cell death; and (6) changes in the composition of the cell membrane or secreted products**



How it starts: at around 9 days, the inner cell mass (or embryoblast) divides into 2 layers, epiblast and hypoblast. The epiblasts migrate and invaginate to form an intermediate layer (later the mesoderm) . This process is correlated with changes in cell-cell adhesion through the *downregulation of cadherins and IgCAMs*.

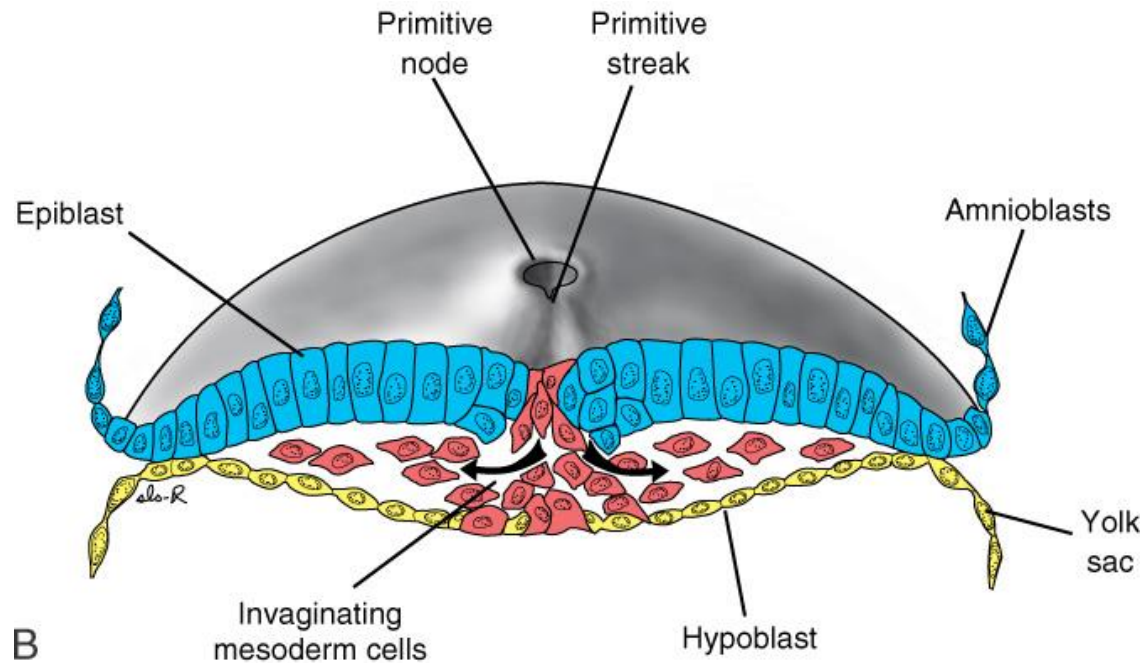

So, even at 9 days, cell cell interaction is critical.

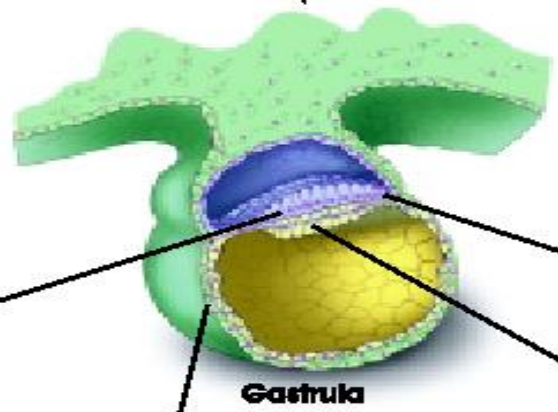
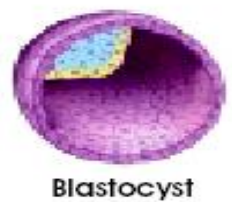

Ectoderm (external layer)

Mesoderm (middle layer)

Endoderm (internal layer)

Germ cells



Skin cells of epidermis

Neuron of brain

Pigment cell

Cardiac muscle

Skeletal muscle cells

Tubule cell of the kidney

Red blood cells

Smooth muscle (in gut)

Pancreatic cell

Thyroid cell

Lung cell (alveolar cell)

Sperm

Egg

Gastrulation paves the way for inductive interactions, which are essential for neurulation and organogenesis.

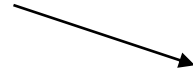

organs

Neurulation : neural tube: Central Nervous System  
Neural crest- migrates away forming different cell types  
Epidermis covering neural tube

# Control

Induction: reorganisation of cells through interaction with other neighbouring cells

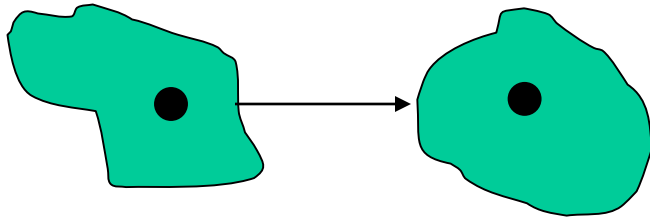

Diffusion of soluble agents

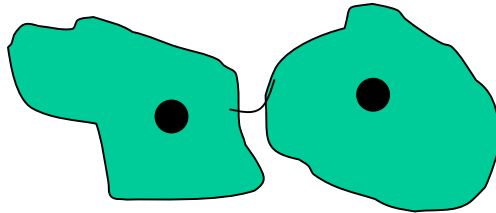

Contact through ECM

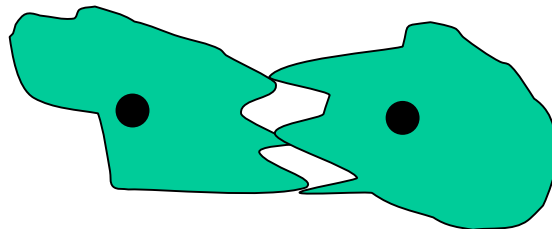

Contact through membrane receptors

Riassumendo, i processi principali  
sono

- Fertilizzazione
- Cleavage
- Gastrulation
- Organogenesi e neurogenesi
- Istogenesi

Come sa la cellula cosa diventare  
e dove andare?

# I meccanismi di controllo

- Asimmetria
- Adesione e Coesione differenziale
- Informazione posizionale
- Campi embrionici/morfogenetici
- Induzione

# I vincoli nella morfogenesi

- Partecipano da 10 a 1000 cellule
- Le dimensioni sono meno di qualche mm
- I tempi sono del ordine di diverse ore o giorni (tempi di diffusione, movimento e differenziazione cellulare)
- L'energia disponibile è ?



# How do structures know where to form?

They require positional information.

In embryonic fields, cell fate often depends on the position of a cell within that field

## How does a cell receive positional information?

Wolpert proposed that pattern formation is a two-step process

- 1<sup>st</sup>, cells in a field receive positional values
  - 2<sup>nd</sup>, cell interpret the positional information based on their genetic information and developmental history
- 
- positional value = signals they receive from elsewhere
  - interpretation = conversion of these signals into gene activity

# French Flag Hypothesis (Lewis Wolpert)

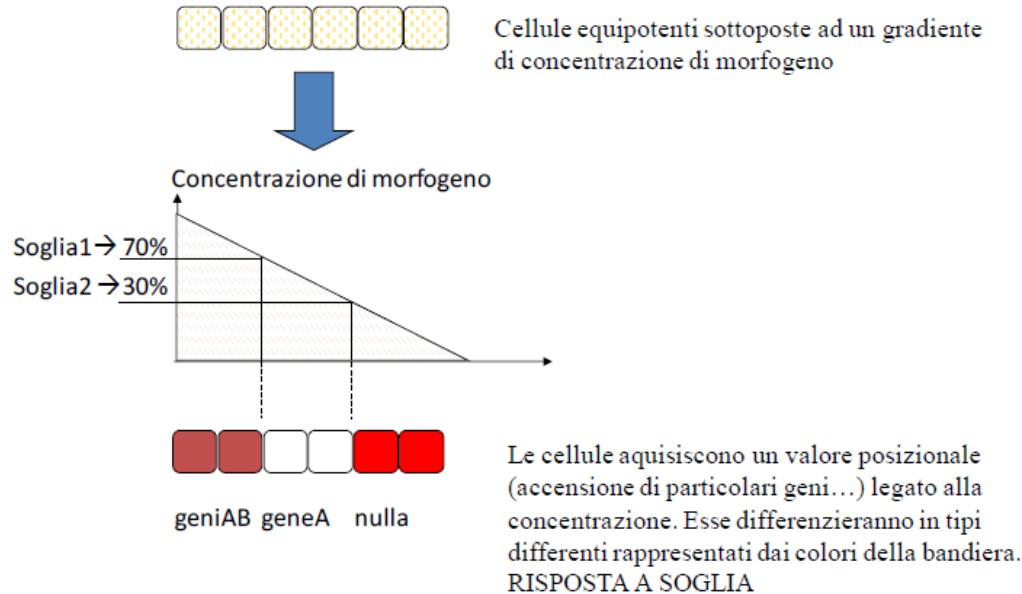

## Control : positional information

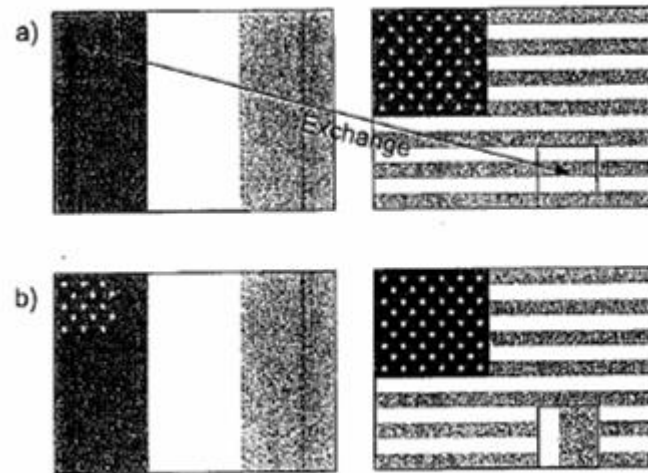

Questo tipo di esperimento fa vedere che l'informazione è contenuto nelle cellule ma viene anche da cellule intorno.  
Es. Si trapianta la zona embrionale della coscia del drosophila sulla zona terminale dell'ala. Cosa forma il trapianto?

## Morphogen and morphogen gradients

A morphogen: a chemical that propagates from one point of the embryo and acts on the cells in a concentration-dependent manner. It can trigger several different developmental pathways depending on its local concentration

Several morphogenic proteins have been identified in vertebrates (activin, BMP (bone morphogenic protein) , Sonic Hedgehog.

- long-ranges signals that specify positional value

# Patterning depends on cellular interactions

- classic studies demonstrated two forms of determination

## a. **Dependent determination**

- surrounding tissue induces (regulates) the grafted tissue to form the structure of the specified location
- Example: exchange future belly epidermis with future mouth epidermis at early gastrula, each develops into the appropriate structure for the location

## b. **Self determination**

- dorsal lip does not get reprogrammed by the local environment
- it reprograms the local environment to form a second embryonic axis.

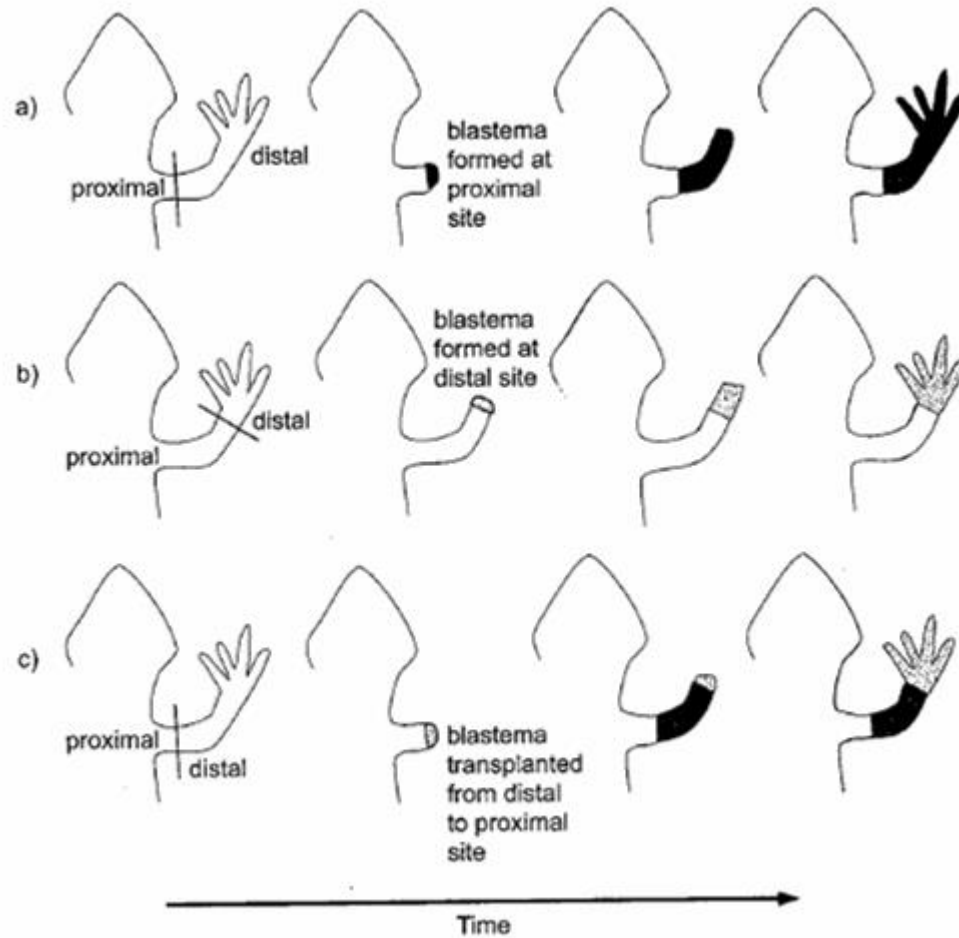

Blastema fate  
is self  
determined

Informazione posizionale

## Classic experiment of Spemann and Schötte (1932)

- exchanged belly epidermis to future mouth regions between frogs and salamanders

- Salamander (*Triturus*) and frog (*Rana*)

- belong to different subclasses of amphibians

- urodeles –tailed amphibians

- anurans – tailless amphibians

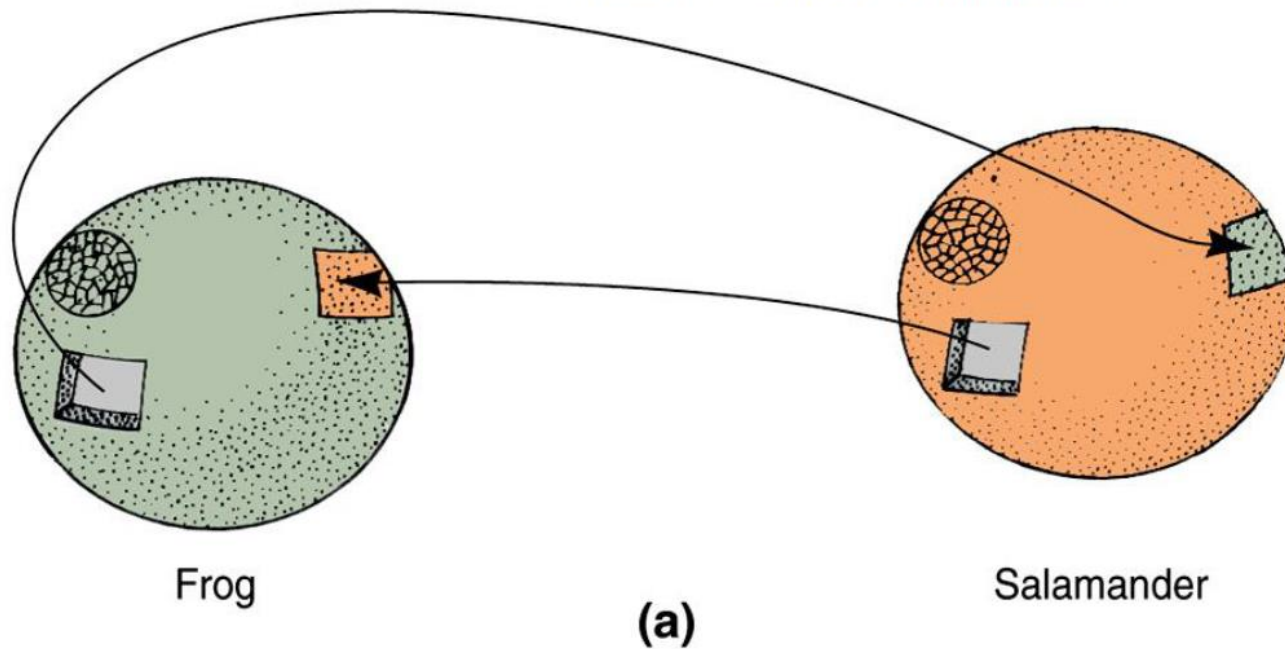

## Structures Formed after Transplantation to Mouth Region of

---

### Donor Species of Prospective Belly Epidermis Graft

### Frog

### Salamander

---

Frog  
Salamander

Horned jaw, sucker  
Teeth, balancers

Horned jaw, sucker  
Teeth, balancers

---

**RESULTS:**  
The grafts underwent  
dependent  
determination/differentia  
tion





## Conclusions from Spemann and Schötte frog/salamander transplants.

- developing tissues were able to read the inductive signals from distant species, thus forming the correct structures.
- different species must use common signals to form mouth parts, but the type of mouth part formed *depended on the grafts genome*
- thus, the response of the grafted tissue was limited to **its** genetic ability
  - either the frog genome did not contain the gene(s) for salamander mouth parts (and/or visa versa)
- In other words, while common genes and common inductive signals are involved, ***different species have unique patterns of gene expression***

La proteina biocide è il primo morfogeno studiato

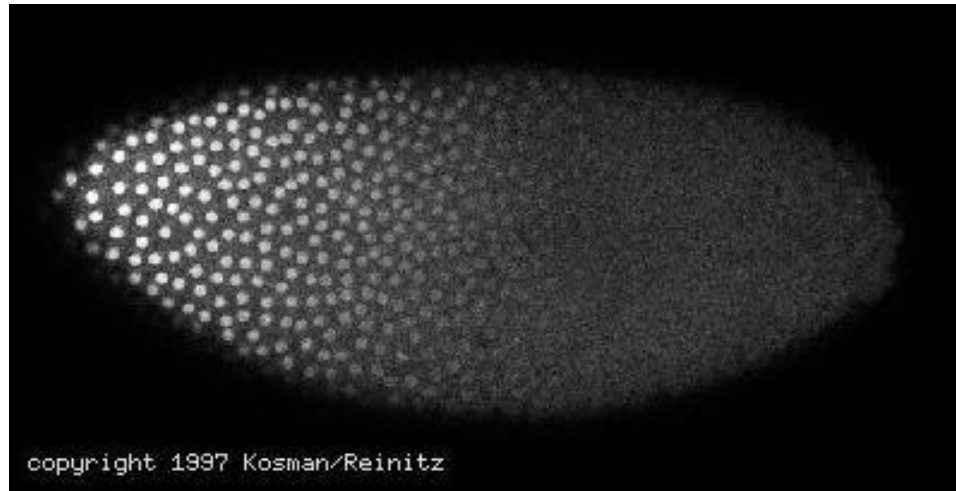

La proteina bicoide è un fattore di trascrizione → regola il livello di espressione di geni nell'embrione (della drosophila). mRNA bicoide viene prodotto dalla madre, tradotto e poi difonde nel embrione dove regola diversi geni a secondo della sua concentrazione.

Transcription factor: protein which binds to DNA promoter regions and regulates the transcription of the gene. The affinity of the binding region determines the threshold concentration required for enhancing expression.

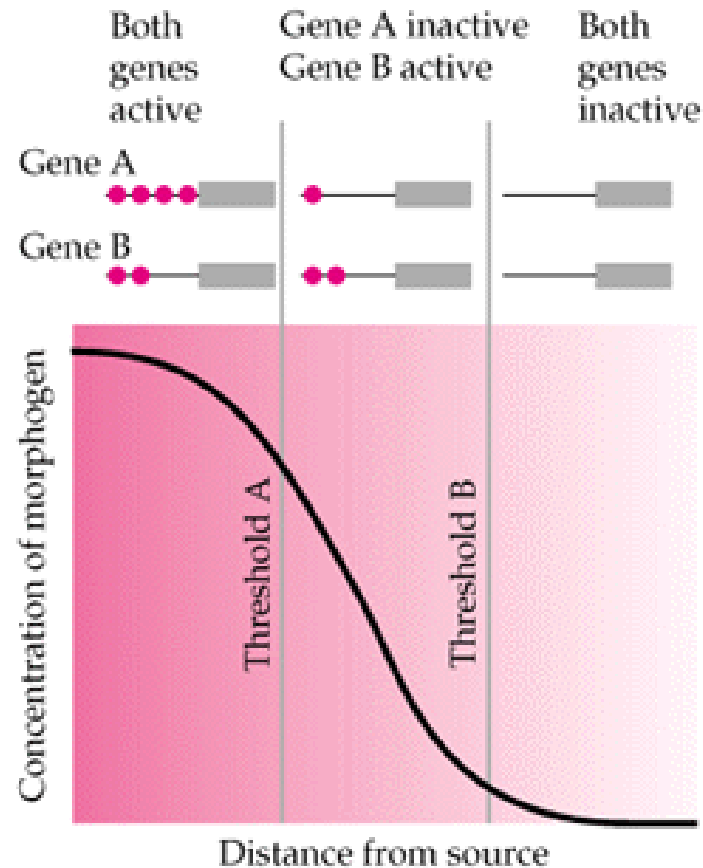

---

**B** Graded Bicoid and anteroposterior polarity

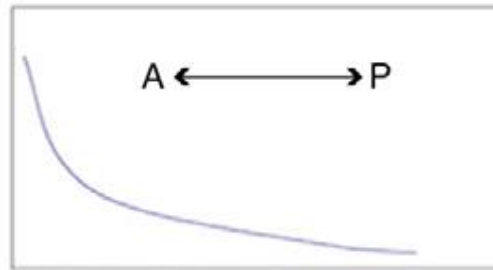

Bicoid distribution

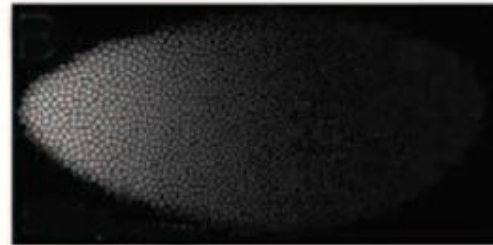

Bicoid protein



*orthodenticle*



*hunchback*

---

These are its characteristics:  $k$  about  $1e-4 \text{ s}^{-1}$

Diffusion constant  $1e-7 \text{ cm}^2/\text{s}$

Size of embryo: about 1000 micron. Bicoid protein diffuses freely into embryo.

$$\frac{dC}{dt} = D \frac{d^2C}{dx^2} - kC$$

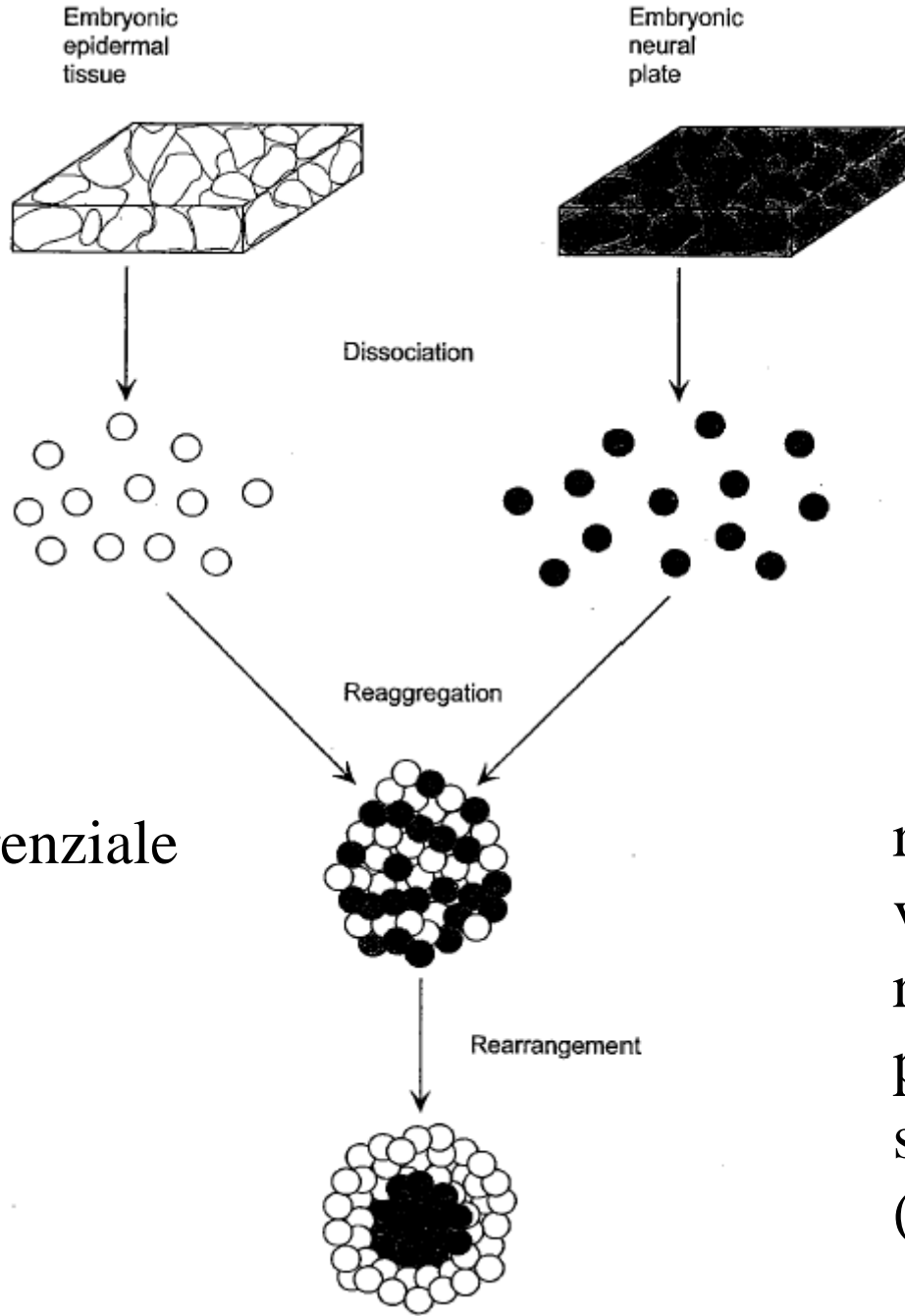

Adesione differenziale

reaggregation in vivo and recreation of primitive structures (Holtfreter)

Steinberg (1963) proposed that cell sorting and movement was simply due to differences in adhesion and cohesion between units. He demonstrated this using thermodynamics.

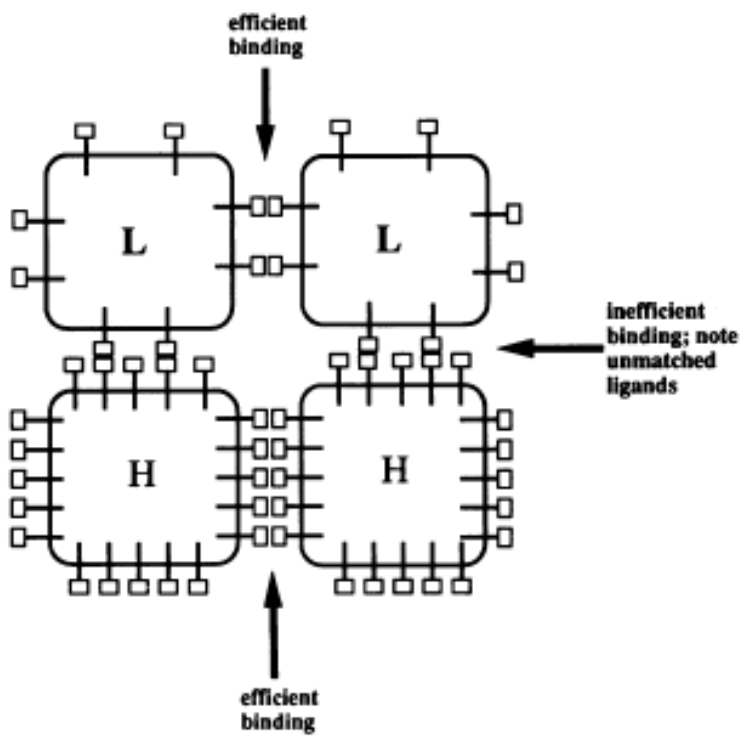



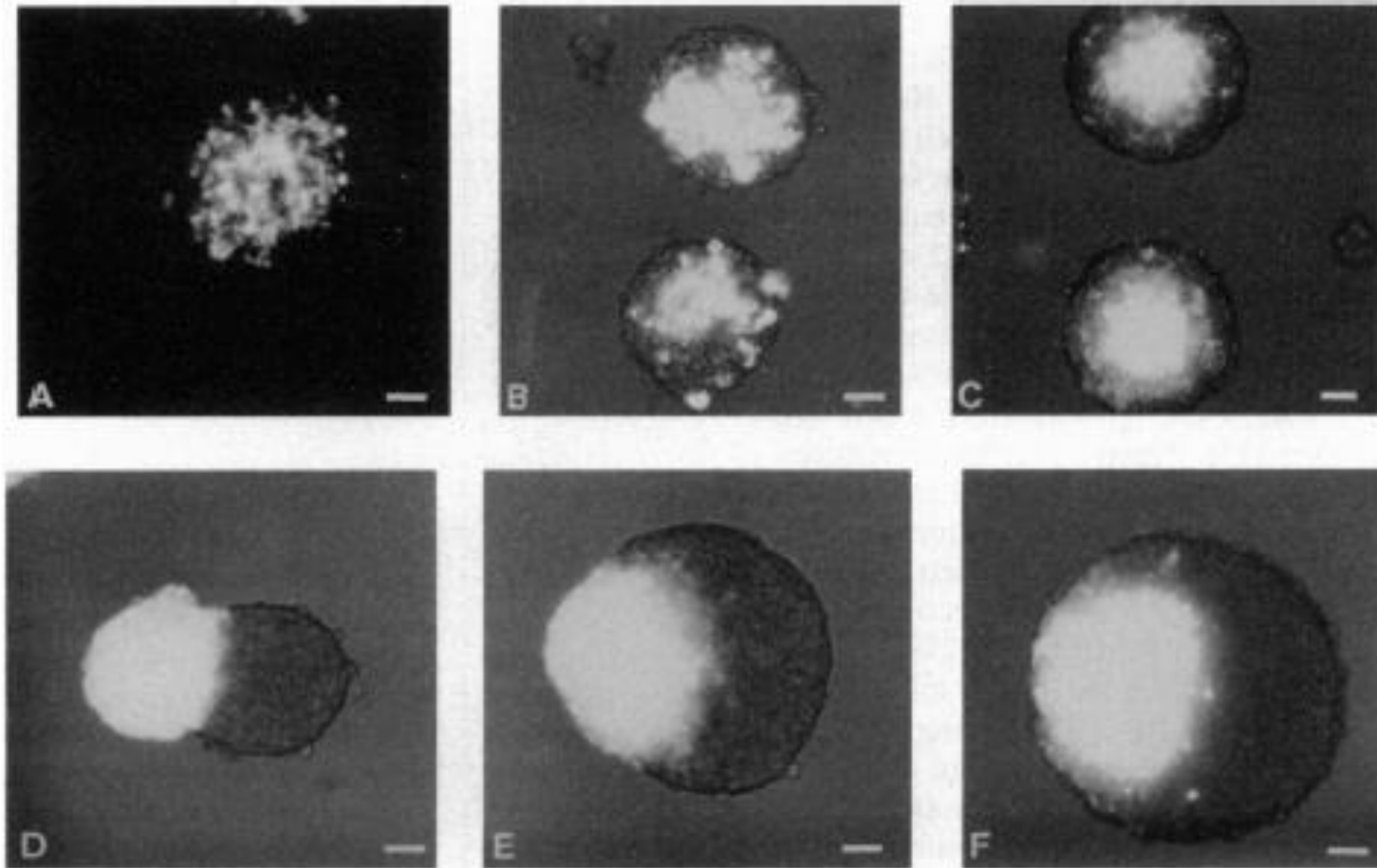

2 cells with different levels of cadherin expression ( 1:20 expression ratio) . Aggregation and sorting in 4 days.

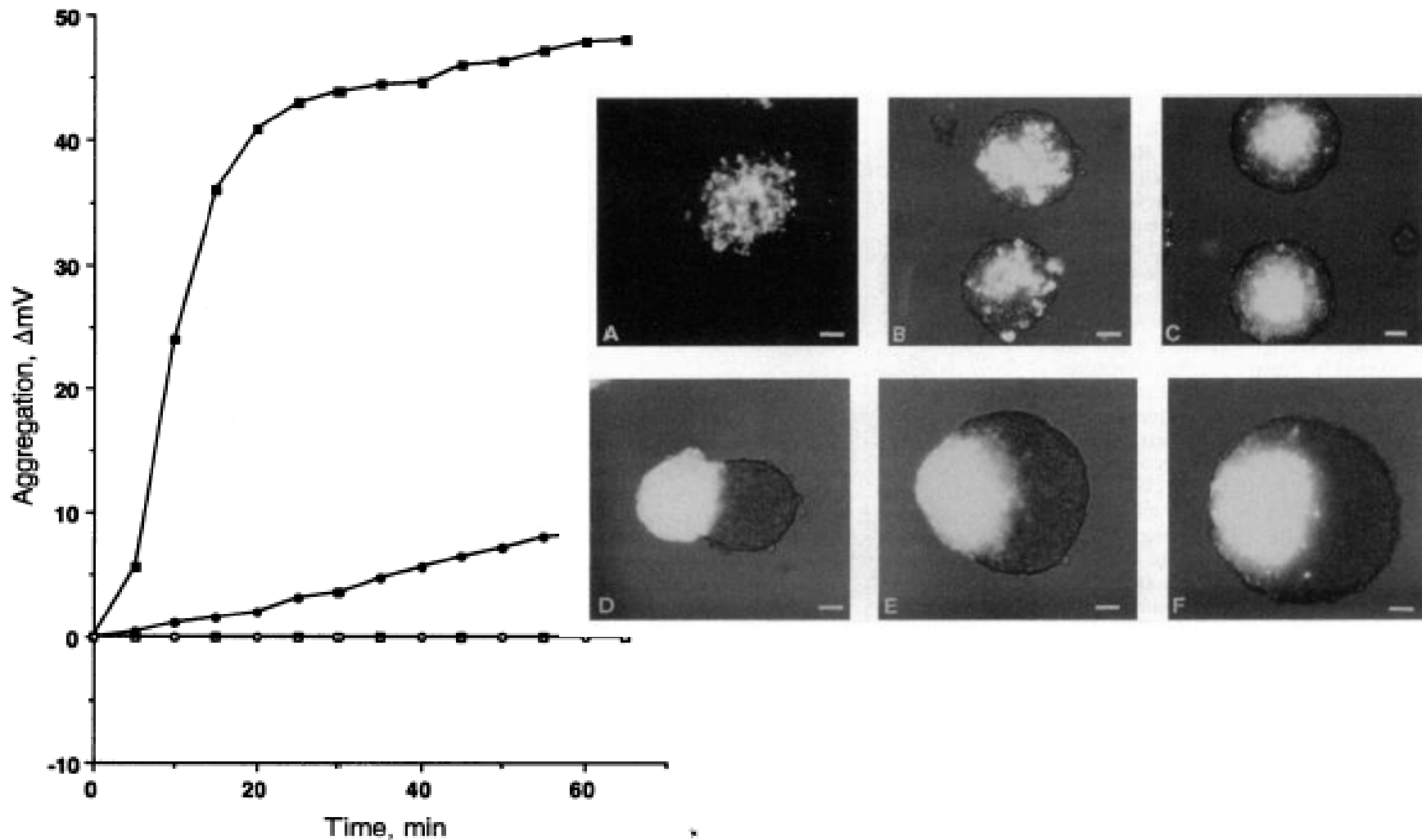

FIG. 1. Cell aggregation (expressed as  $\Delta mV$  reading of the aggregometer). ■, PL $\beta$ 2 cells +  $Ca^{2+}$ ; □, PL $\beta$ 2 cells in low  $Ca^{2+}$ ; ●, PLs5 cells +  $Ca^{2+}$ ; and ○, PLs5 cells in low  $Ca^{2+}$ .

PLs5- esprimono poco P-cadherin, PL $\beta$ 2 ne esprimono 20 volte piu. Spiegare le curve

Control: positional information through differences in cohesion and adhesion

